

## FEATURES

Technology	POS (Per Outlet Switching)
Energy Metering	Voltage(V), Current(A), Active Power(W), Apparent Power (VA), Reactive Power (var), PF, Frequency(Hz), kWh
Metering per Input Line	Yes (Branch Circuit and Total Current) Accuracy 1%
Metering per Output Receptacle	No
Remote Outlet Switching	Yes
Ethernet Port	2 Gigabit Ethernet ports to access the PDU from 2 different networks
Networking Protocols	DHCP, IPv4 and IPv6, DNS, http / https, SSHv.2, SNMP v1 / v2c / v3, SNMP TRAPS / SETS / GETS, SMTP, Modbus , TCP, RADIUS, Syslog, TLS 1.3, SNTp, ARP, ICMP, ICMPv6, UDP, NDP
PDU Cascading	16 PDUs
Power Share	Yes
Network Controller	Replaceable Hot Swapable controller with 4 button OLED display
Residual Current Monitoring	No (optional)
Rack Acces Control	Compatible with DCIM solutions
USB Ports	2 USB A ports WiFi networking,webcam,PDU configuration and mobile interface
Environmental Sensors	All in one Temperature and Humidity sensor with 2 digital inputs (for connect air flow, door sensor, water leak, smoke detector and Vibration sensor) plug and play bus allows to connect 8 EMD devices in one PDU

## INPUT

Plug	IEC 60309 1P+N+E 6h 16A 250V SINGLE PHASE
Lead Length	3 meter
Cable Type	H05VV-F3G1.5 mm <sup>2</sup>
Max. Input Load	16A
Rated Input Voltage	190-250V Single phase
Frequency	50-60Hz
Power Capacity	3680W

## OUTPUT

Rated Output Voltage	190-250V Single phase
Output Types	12 IEX (C13/C19) combo with LED (Max rate 16A) EN61984+UL498 certified
Overload Proteciton	None

## CHASSIS

Dimensions (W x D x H)	862 x 60 x 72 mm
Color	RAL 9004 black powder coat
Mounting Options	4 mounting options (see page 2)
Required Torque for Mounting Screws	≥2.54N·m (25.9kgf·cm or 22.4 in·lbs)

## OPERATING ENVIRONMENT

Temperature Range	0° to 60° C (30° to 140° F)
Humidity	0 - 95 %
Elevation	0 - 4000 Meters

## CONFORMANCE

IEC 62368-1 (Third Edition)



A

B

A

B

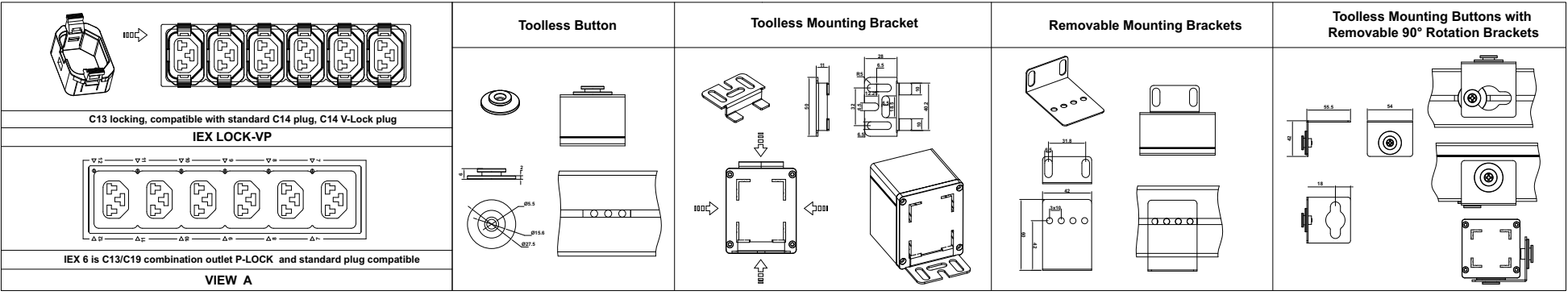

Chassis Color	Code
Black	Standard color
White	W
Red	R
Blue	A
Green	G
Orange	O
Grey	GY
Yellow	Y

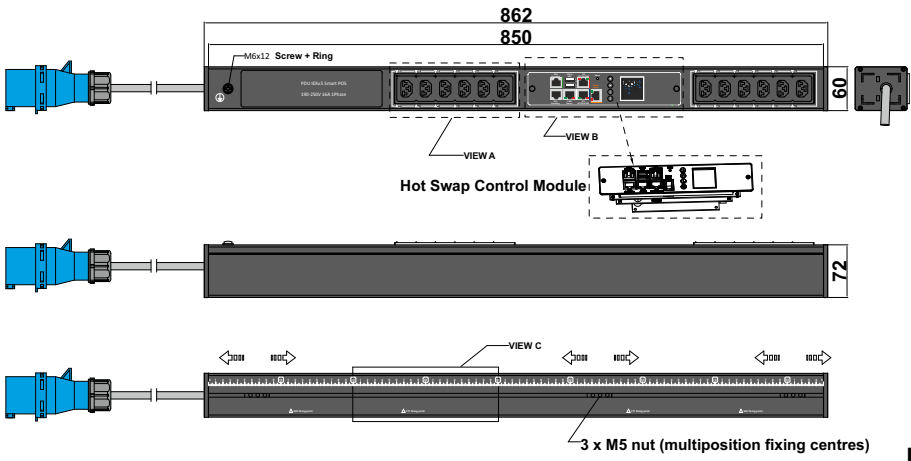

Packing content:

IEX Lock-VP  X12 Black

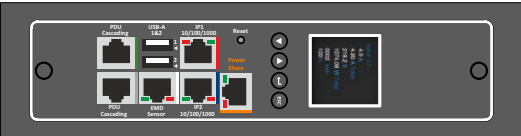

VIEW B:

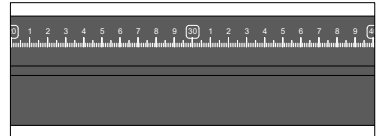

VIEW C:



<b>POS Series</b> Inlet Power Monitoring Per Outlet Switching Environmental Monitoring	<b>OUTPUT</b> (12) IEX (C13/C19) combo with LED Black (Max rate 16A)	<b>OPERATING TEMPERATURE</b> 0° to 60°C	<b>Revisions</b>		
			Rev	Description	Date
<b>INPUT</b> 190-250VAC 16A 50HZ IEC60309 16A 1P+N+E Plug 3m H05VV-F3G1.5mm² Power Lead	<b>BRANCH CIRCUITS</b>	<b>MOUNTING ACESORIES</b> (2) Toolless Button (2) Toolless Mounting Bracket (2) Removable Mounting Brackets (2) Toolless Mounting Buttons with Removable 90° Rotation Brackets			

DRAWING TYPE		IEXPOS501216AV	
 (NO PERMISSION, NO CHANGING)			
unit=mm		<b>Housing</b>	Aluminium
TECHNICAL STANDARD IT11; NO RUST NO FLAW ON THE SURFACE			Black Powder Coating
FILLET R0.5 ANGLE ±0.5° FIRST ANGLE			RAL9004
			
		DATE 15-01-2023	

- Low cost locking solution t both ends
- Different colors available
- Patented IEX locking system
- Locking sleeve for C13 and C19 plugs
- VDE, UL approved

# IEX PATENTED LOCKING SOCKET - POWER CORD SOLUTION



**C14 - C13 Sleeve**  
H05VV-F3G1 mm<sup>2</sup>

Color	0,5M	1M	2M
Black	✓	✓	✓
Red	✓	✓	✓
Blue	✓	✓	✓

**C14PLOCK - C13 Sleeve**  
H05VV-F3G1 mm<sup>2</sup>

Color	0,5M	1M	2M
Black	✓	✓	✓
Red	✓	✓	✓
Blue	✓	✓	✓

**C20PLOCK - C19 Sleeve**  
H05VV-F3G1,5 mm<sup>2</sup>

Color	1M	2M
Black	✓	✓
Red	✓	✓
Blue	✓	✓

**C20PLOCK - C13 Sleeve**  
H05VV-F3G1 mm<sup>2</sup>

Color	1M	2M
Black	✓	✓
Red	✓	✓
Blue	✓	✓

1

2

3

4

5

6

7

8

A

B



A

B

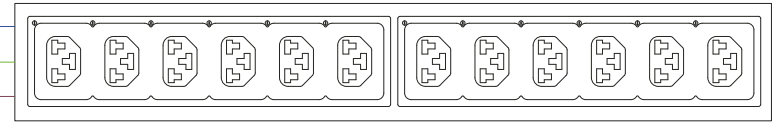
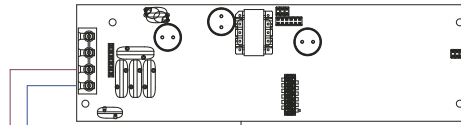
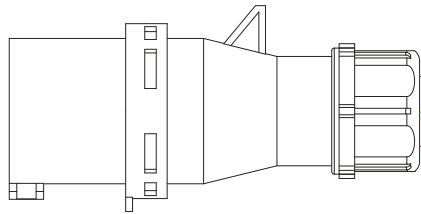
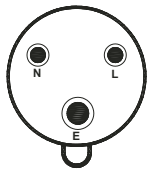
### Meter Board



CT1

DRAWING TYPE  <small>(NO PERMISSION, NO CHANGING)</small>		IEXPOS501216AV-wiring	
unit=mm		Housing	
TECHNICAL STANDARD IT11; NO RUST NO FLAW ON THE SURFACE			
FILLET	R0.5		
ANGLE	±0.5°		
FIRST ANGLE 			

1

2

3

6

7

8

F

F

QTY	Part No.
1	PD090-3

Part No.  
PP029-3

Part No.  
PP081-2

Part No.  
PP070-1

QTY	Part No.
12	IEXLOCKB

Part No.  
PP030-1

QTY	Part No.
2	MT190

QTY	Part No.
2	MT124-1

QTY	Part No.
2	PL178

QTY	Part No.
2	MT124-1

QTY	Part No.
2	MT190-2

QTY	Part No.
6	MT124

QTY	Part No.
2	PL178

QTY	Part No.
2	MT190-3

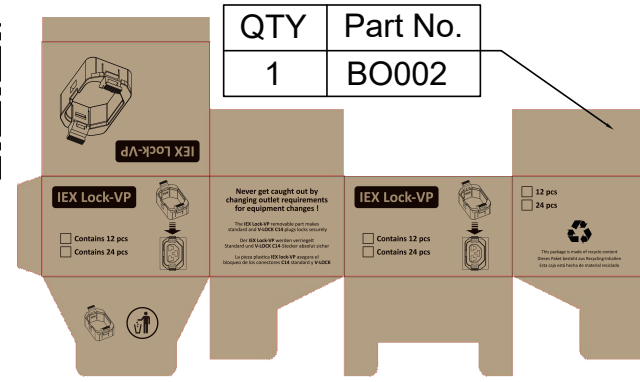

QTY	Part No.
1	BO002

**PK033**  
Section 23.5x9 cm Length 120 cm

Weight: 6kg(2 PDU)