





FEATURES	
Technology	POM (Per Outlet Metering)
Energy Metering	Voltage(V), Current(A), Active Power(W), Apparent Power (VA), Reactive Power (var), PF, Frequency(Hz), kWh
Metering per Input Line	Yes (Branch Circuit and Total Current) Accuracy 1%
Metering per Output Receptacle	Yes
Remote Outlet Switching	No
Ethernet Port	2 Gigabit Ethernet ports to acces the PDU from 2 different networks
Networking Protocols	DHCP, IPv4 and IPv6, DNS, http / https, SSHv.2, SNMP v1 / v2c / v3, SNMP TRAPS / SETS / GETS, SMTP, Modbus , TCP, RADIUS, Syslog, TLS 1.3, SNTP, ARP, ICMP, ICMPv6, UDP, NDP
PDU Cascading	16 PDUs
Power Share	Yes
Network Controller	Replaceable Hot Swapable controller with 4 button OLED display
Residual Current Monitoring	No
Rack Acces Control	Compatible with DCIM solutions
USB Ports	2 USB A ports WiFi networking,webcam,PDU configuration and mobile interface
Environmental Sensors	All in one Temperature and Humidity sensor with 2 digital inputs (for connect air flow, door sensor, water leak, smoke detector and Vibration sensor) plug and play bus allows to connect 8 EMD devices in one PDU
INPUT	
Plug	IEC60309 3P+N+E 6h 16A 380-415V
Lead Length	3 meter
Cable Type	H07RN-F5G2.5 mm ²
Max. Input Load	16A
Rated Input Voltage	380-415V three phase
Frequency	50-60Hz
Power Capacity	11kW
OUTPUT	
Rated Output Voltage	190-250V Single phase
Output Types	30 IEX (C13/C19) combo (Max rate 16A) EN61984+UL498 certified
Overload Protection	None
CHASSIS	
Dimensions (W x D x H)	1612 x 60 x 72 mm
Color	RAL 9004 black powder coat
Mounting Options	4 mounting options (see page 2)
Required Torque for Mounting Screws	≥2.54N·m (25.9kgf·cm or 22.4 in·lbs)
OPERATING ENVIRONMENT	
Temperature Range	0° to 60° C (30° to 140° F)
Humidity	0 - 95 %
Elevation	0 - 4000 Meters
CONFORMANCE	
IEC 62368-1 (Third Edition)	
   	



VIEW B:

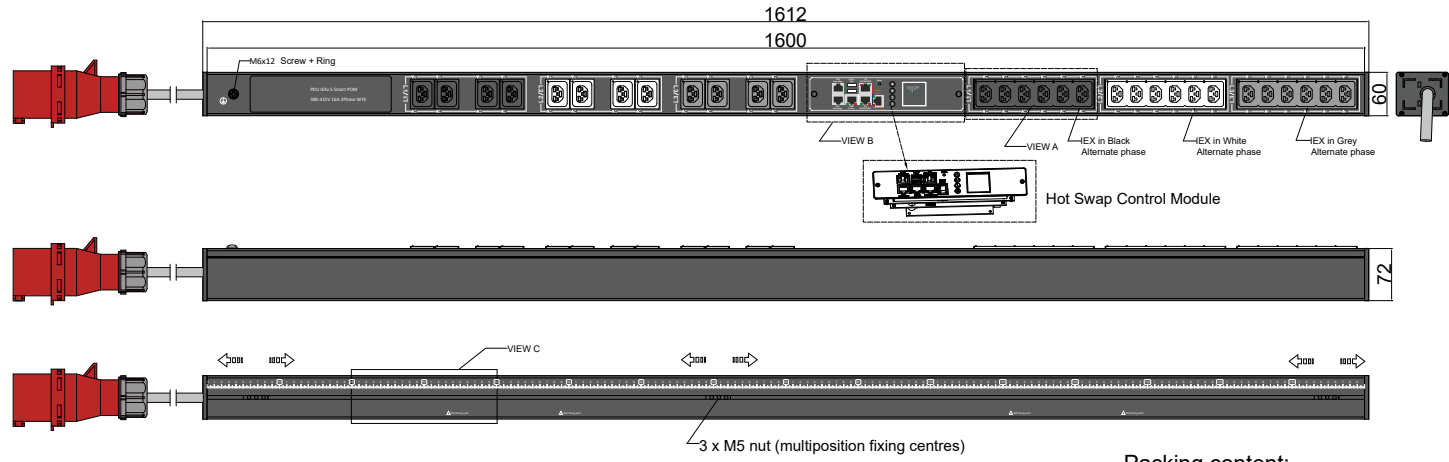
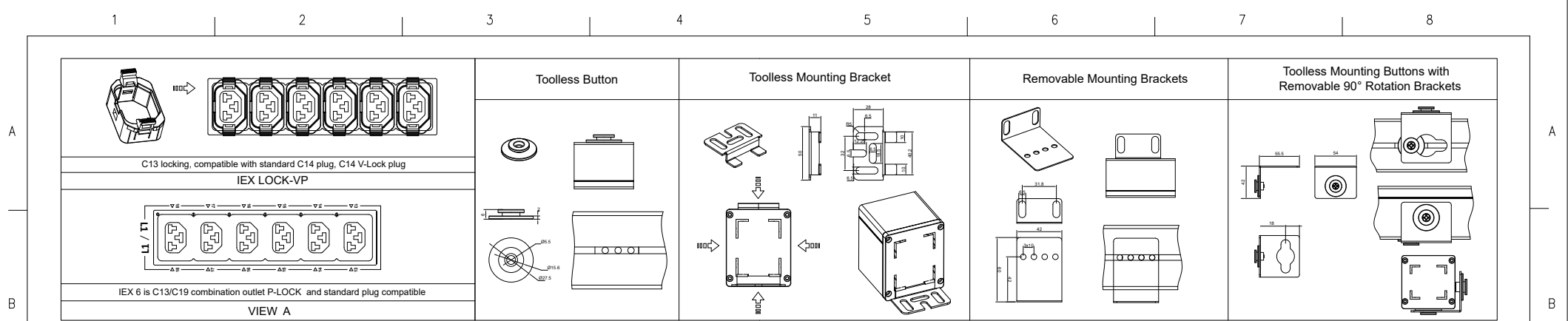
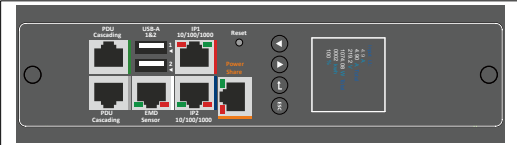

VIEW C:

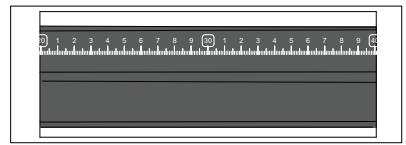



Chassis Color	Code
Black	Standard color
White	W
Red	R
Blue	A
Green	G
Orange	O
Grey	GY
Yellow	Y

Packing content:

IEX Lock-VP  X30 (black,white,grey)

POM Series	OUTPUT	OPERATING TEMPERATURE	Revisions		
Inlet Power Monitoring Per Outlet Monitoring Environmental Monitoring	(10) IEX (C13/C19) combo Black (Max rate 16A) (10) IEX (C13/C19) combo White (Max rate 16A) (10) IEX (C13/C19) combo Grey (Max rate 16A)	0° to 60°C	Rev	Description	Date
INPUT 380-415VAC 16A 50HZ IEC60309 16A 3P+N+E Plug 3m H07RN-F5G2.5mm ² Power Lead	BRANCH CIRCUITS	MOUNTING ACCESSORIES (2) Toolless Button (2) Toolless Mounting Bracket (2) Removable Mounting Brackets (2) Toolless Mounting Buttons with Removable 90° Rotation Brackets			

DRAWING TYPE	IEXPOM503016A3PV	
 (NO PERMISSION,NO CHANGING)	Aluminium	
unit=mm	Black Powder Coating	
TECHNICAL STANDARD IT11; NO RUST NO FLAW ON THE SURFACE	RAL9004	
FILLET R0.5 ANGLE ±0.5° FIRST ANGLE		

- Low cost locking solution at both ends
- Different colors available
- Patented IEX locking system
- Locking sleeve for C13 and C19 plugs
- VDE, UL approved

IEX PATENTED LOCKING SOCKET - POWER CORD SOLUTION



C14 - C13 Sleeve

H05VV-F3G1 mm²

Color	0,5M	1M	2M
Black	✓	✓	✓
Red	✓	✓	✓
Blue	✓	✓	✓

C14PLOCK - C13 Sleeve

H05VV-F3G1 mm²

Color	0,5M	1M	2M
Black	✓	✓	✓
Red	✓	✓	✓
Blue	✓	✓	✓

C20PLOCK - C19 Sleeve

H05VV-F3G1,5 mm²



Color	1M	2M
Black	✓	✓
Red	✓	✓
Blue	✓	✓

C20PLOCK - C13 Sleeve

H05VV-F3G1 mm²

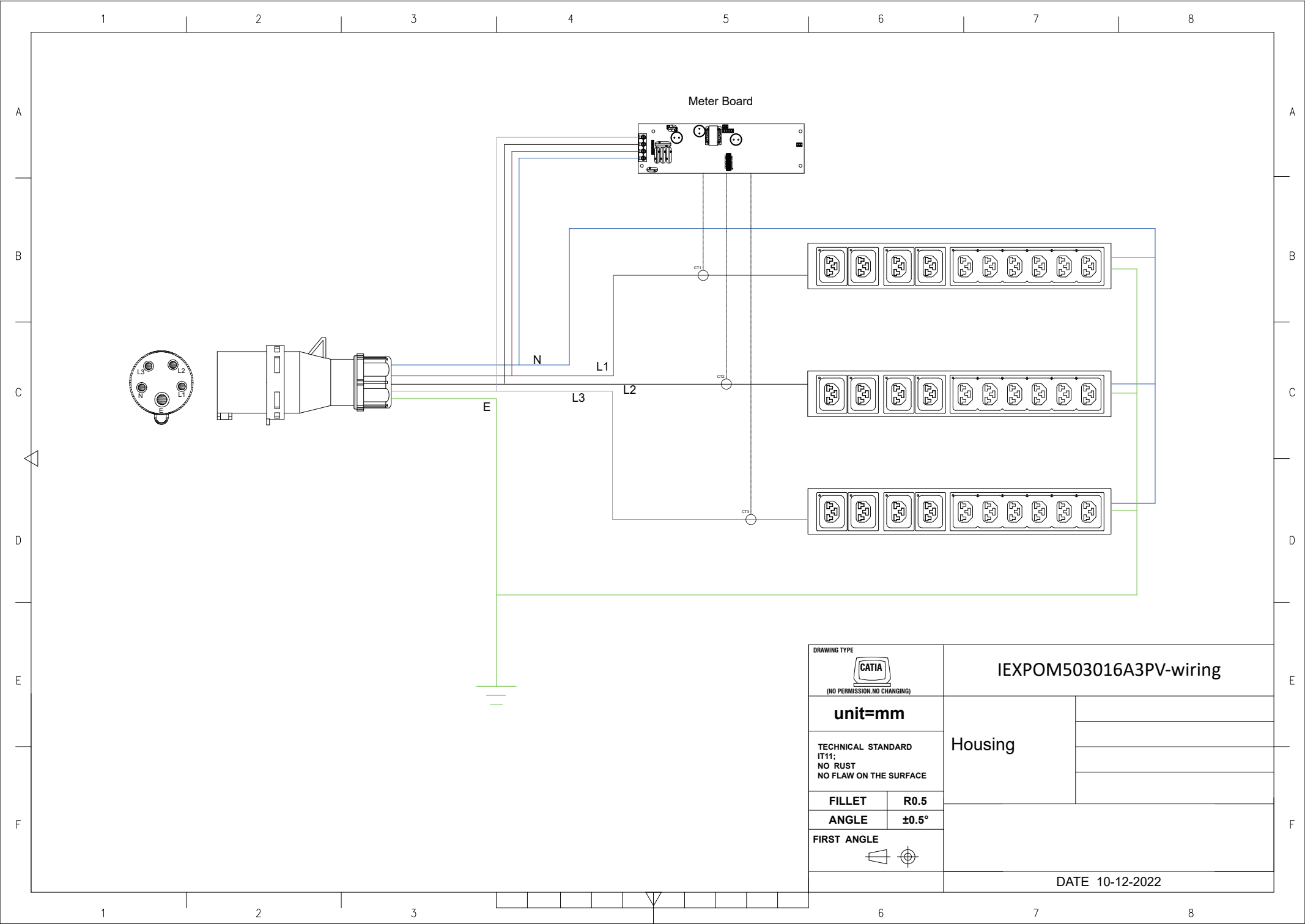
Color	1M	2M
Black	✓	✓
Red	✓	✓
Blue	✓	✓



DRAWING TYPE		IEXPOM503016A3PV-wiring	
 (NO PERMISSION, NO CHANGING)		Housing	
unit=mm TECHNICAL STANDARD IT11; NO RUST NO FLAW ON THE SURFACE			
FILLET	R0.5		
ANGLE	±0.5°		
FIRST ANGLE			
			
		DATE 10-12-2022	

QTY	Part No.
1	PD090-3

Part No.
PP029-3

Part No.
PP081-5

Part No.
PP030-3

Part No.
PP070-4

QTY	Part No.
10	IEXLOCKB
10	IEXLOCKW
10	IEXLOCKG

QTY	Part No.
2	MT190

QTY	Part No.
2	MT124-1

QTY	Part No.
2	PL178

QTY	Part No.
2	MT124-1

QTY	Part No.
2	MT190-2

QTY	Part No.
6	MT124

QTY	Part No.
2	PL178

QTY	Part No.
2	MT190-3

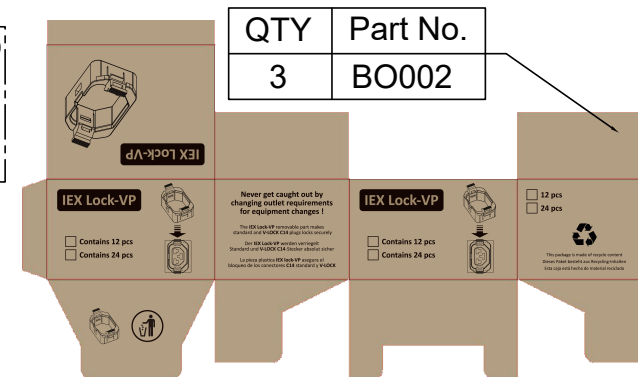

QTY	Part No.
3	BO002

PK036
Section 23.5x9 cm Length 200 cm

Weight: 9kg(2 PDU)