

FEATURES

Technology	PIM (Per Inlet Monitoring)
Energy Metering	Voltage(V), Current(A), Active Power(W), Apparent Power (VA), Reactive Power (var), PF, Frequency(Hz), kWh
Metering per Input Line	Yes (Branch Circuit and Total Current) Accuracy 1%
Metering per Output Receptacle	No
Remote Outlet Switching	No
Ethernet Port	2 Gigabit Ethernet ports to access the PDU from 2 different networks
Networking Protocols	DHCP, IPv4 and IPv6, DNS, http / https, SSHv.2, SNMP v1 / v2c / v3, SNMP TRAPS / SETS / GETS, SMTP, Modbus , TCP, RADIUS, Syslog, TLS 1.3, SNTP, ARP, ICMP, ICMPv6, UDP, NDP
PDU Cascading	16 PDUs
Power Share	Yes
Network Controller	Replaceable Hot Swapable controller with 4 button OLED display
Residual Current Monitoring	No (optional)
Rack Access Control	Compatible with DCIM solutions
USB Ports	2 USB A ports WiFi networking, webcam, PDU configuration and mobile interface
Environmental Sensors	All in one Temperature and Humidity sensor with 2 digital inputs (for connect air flow, door sensor, water leak, smoke detector and Vibration sensor) plug and play bus allows to connect 8 EMD devices in one PDU

INPUT

Plug	IEC 60309 1P+N+E 6h 16A 250V SINGLE PHASE
Lead Length	3 meter
Cable Type	H05VV-F3G1.5 mm ²
Max. Input Load	16A
Rated Input Voltage	190-250V Single phase
Frequency	50-60Hz
Power Capacity	3680W

OUTPUT

Rated Output Voltage	190-250V Single phase
Output Types	30 IEX (C13/C19) combo (Max rate 16A) EN61984+UL498 certified
Overload Protection	None

CHASSIS

Dimensions (W x D x H)	1342 x 60 x 72 mm
Color	RAL 9004 black powder coat
Mounting Options	4 mounting options (see page 2)
Required Torque for Mounting Screws	≥2.54N·m (25.9kgf·cm or 22.4 in·lbs)

OPERATING ENVIRONMENT

Temperature Range	0° to 60° C (30° to 140° F)
Humidity	0 - 95 %
Elevation	0 - 4000 Meters

CONFORMANCE

IEC 62368-1 (Third Edition)



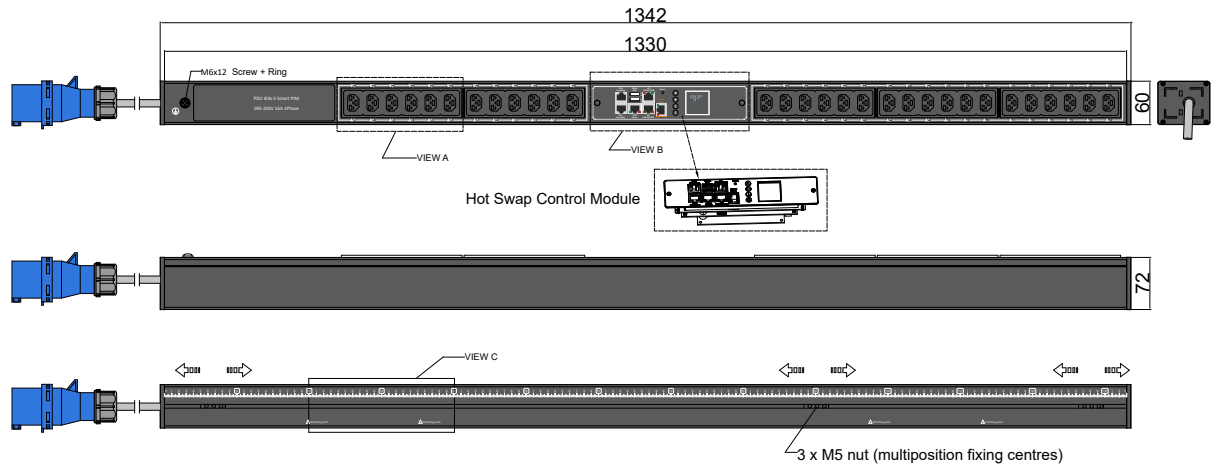
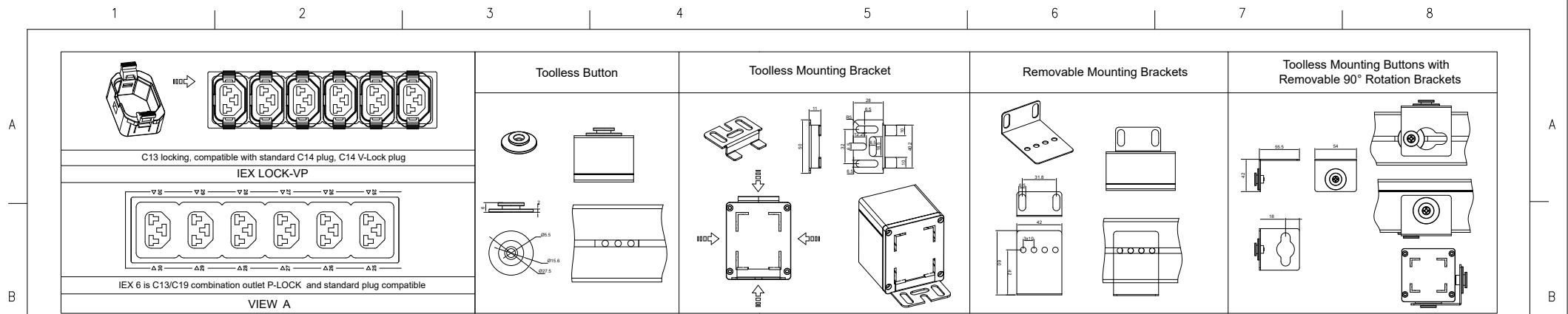

VIEW B:

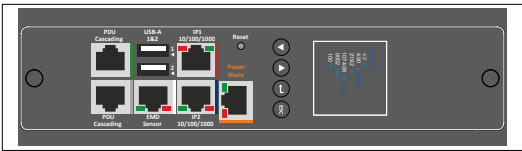

VIEW C:

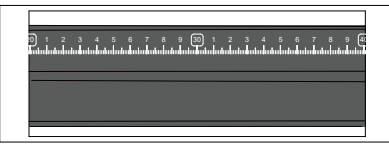



Chassis Color	Code
Black	Standard color
White	W
Red	R
Blue	A
Green	G
Orange	O
Grey	GY
Yellow	Y

Packing content:

IEX Lock-VP  X30 Black

PIM Series Inlet Power Monitoring Environmental Monitoring	OUTPUT (30) IEX (C13/C19) combo Black (Max rate 16A)	OPERATING TEMPERATURE 0° to 60°C	Revisions		
			Rev	Description	Date
INPUT 190-250VAC 16A 50HZ IEC60309 16A 1P+N+E Plug 3m H05VV-F3G1.5mm² Power Lead	BRANCH CIRCUITS	MOUNTING ACCESSORIES (2) Toolless Button (2) Toolless Mounting Bracket (2) Removable Mounting Brackets (2) Toolless Mounting Buttons with Removable 90° Rotation Brackets			

DRAWING TYPE  (NO PERMISSION, NO CHANGING)	IEXPIM503016AV	
unit=mm TECHNICAL STANDARD IT11: NO RUST NO FLAW ON THE SURFACE	Housing	Aluminium Black Powder Coating RAL9004
FILLET R0.5 ANGLE ±0.5° FIRST ANGLE 		
DATE 10-04-2023		

- Low cost locking solution at both ends
- Different colors available
- Patented IEX locking system
- Locking sleeve for C13 and C19 plugs
- VDE, UL approved

IEX PATENTED LOCKING SOCKET - POWER CORD SOLUTION



C14 - C13 Sleeve

H05VV-F3G1 mm²

Color	0,5M	1M	2M
Black	✓	✓	✓
Red	✓	✓	✓
Blue	✓	✓	✓

C14PLOCK - C13 Sleeve

H05VV-F3G1 mm²

Color	0,5M	1M	2M
Black	✓	✓	✓
Red	✓	✓	✓
Blue	✓	✓	✓

C20PLOCK - C19 Sleeve

H05VV-F3G1,5 mm²



Color	1M	2M
Black	✓	✓
Red	✓	✓
Blue	✓	✓

C20PLOCK - C13 Sleeve

H05VV-F3G1 mm²

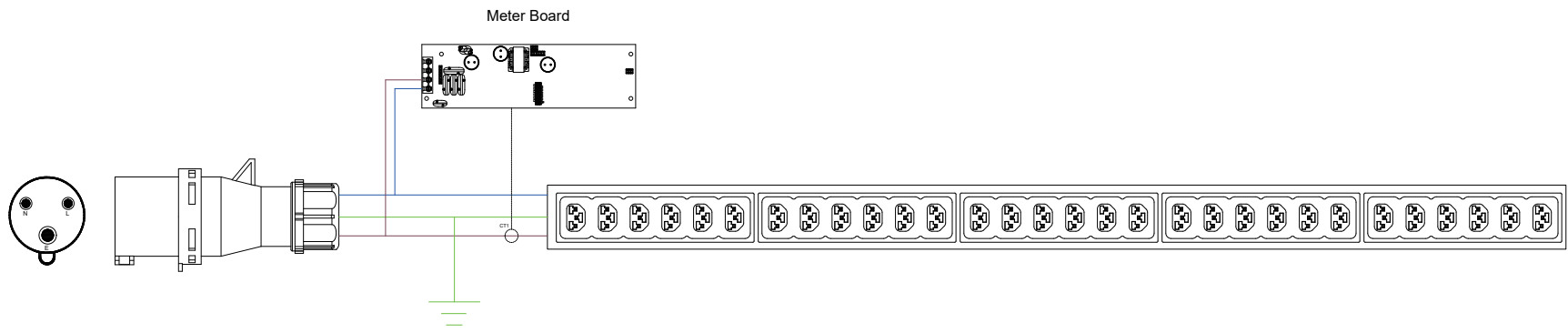
Color	1M	2M
Black	✓	✓
Red	✓	✓
Blue	✓	✓



DRAWING TYPE		IEXPIM503016AV-wiring	
 (NO PERMISSION, NO CHANGING)		Housing	
unit=mm			
TECHNICAL STANDARD IT11; NO RUST NO FLAW ON THE SURFACE			
FILLET	R0.5		
ANGLE	±0.5°		
FIRST ANGLE			
			
		DATE 26-06-2021	

QTY	Part No.
1	PD090-3

Part No.	PP029-3
----------	---------

Part No.	PP081-3
----------	---------

Part No.	PP030-1
----------	---------

Part No.	PP070-2
----------	---------

QTY	Part No.
30	IEXLOCKB

QTY	Part No.
2	MT190

QTY	Part No.
2	MT124-1

QTY	Part No.
2	PL178

QTY	Part No.
2	MT124-1

QTY	Part No.
2	MT190-2

QTY	Part No.
6	MT124

QTY	Part No.
2	PL178

QTY	Part No.
2	MT190-3

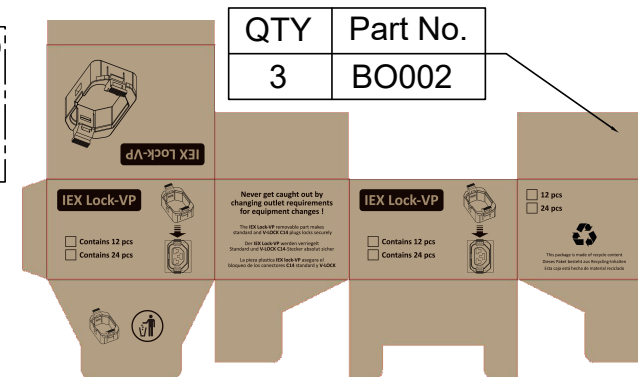

QTY	Part No.
3	BO002

PK034
Section 23.5x9 cm Length 150 cm

Weight: 7kg(2 PDU)