

FEATURES

Technology	POMS (Per Outlet Metering & Switching)
Energy Metering	Voltage(V), Current(A), Active Power(W), Apparent Power (VA), Reactive Power (var), PF, Frequency(Hz), kWh
Metering per Input Line	Yes (Branch Circuit and Total Current) Accuracy 1%
Metering per Output Receptacle	Yes
Remote Outlet Switching	Yes
Ethernet Port	2 Gigabit Ethernet ports to access the PDU from 2 different networks
Networking Protocols	DHCP, IPv4 and IPv6, DNS, http / https, SSHv.2, SNMP v1 / v2c / v3, SNMP TRAPS / SETS / GETS, SMTP, Modbus , TCP, RADIUS, Syslog, TLS 1.3, SNTP, ARP, ICMP, ICMPv6, UDP, NDP
PDU Cascading	16 PDUs
Power Share	Yes
Network Controller	Replaceable Hot Swapable controller with 4 button OLED display
Residual Current Monitoring	No
Rack Access Control	Compatible with DCIM solutions
USB Ports	2 USB A ports WiFi networking, webcam, PDU configuration and mobile interface
Environmental Sensors	All in one Temperature and Humidity sensor with 2 digital inputs (for connect air flow, door sensor, water leak, smoke detector and Vibration sensor) plug and play bus allows to connect 8 EMD devices in one PDU

INPUT

Plug	IEC 60309 1P+N+E 6h 32A 250V SINGLE PHASE
Lead Length	3 meter
Cable Type	H07RN-F3G4.0 mm ²
Max. Input Load	32A
Rated Input Voltage	190-250V Single phase
Frequency	50-60Hz
Power Capacity	7360W

OUTPUT

Rated Output Voltage	190-250V Single phase
Output Types	24 IEX (C13/C19) combo with LED (Max rate 16A) EN61984+UL498 certified
Overload Protection	(2) 1 Pole Carling 16A J Series J51-BO-24-616-M1D-D3

CHASSIS

Dimensions (W x D x H)	1412 x 60 x 72 mm
Color	RAL 9004 black powder coat
Mounting Options	4 mounting options (see page 2)
Required Torque for Mounting Screws	≥2.54N·m (25.9kgf·cm or 22.4 in·lbs)

OPERATING ENVIRONMENT

Temperature Range	0° to 60° C (30° to 140° F)
Humidity	0 - 95 %
Elevation	0 - 4000 Meters

CONFORMANCE

IEC 62368-1 (Third Edition)



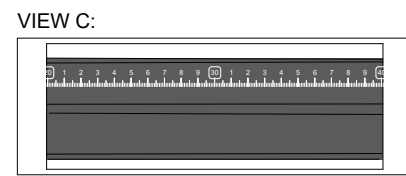
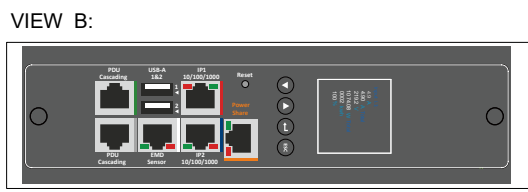
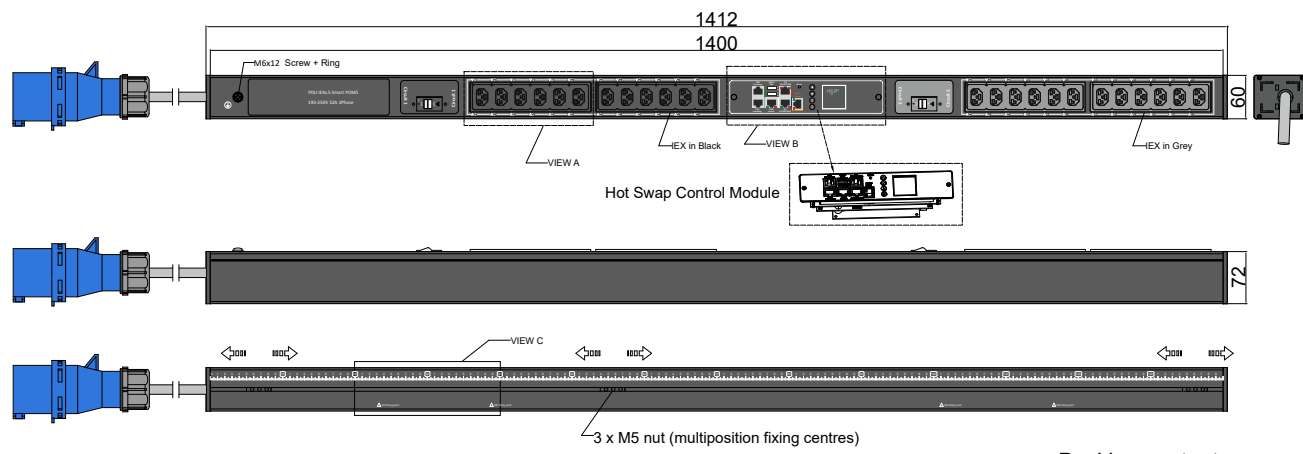
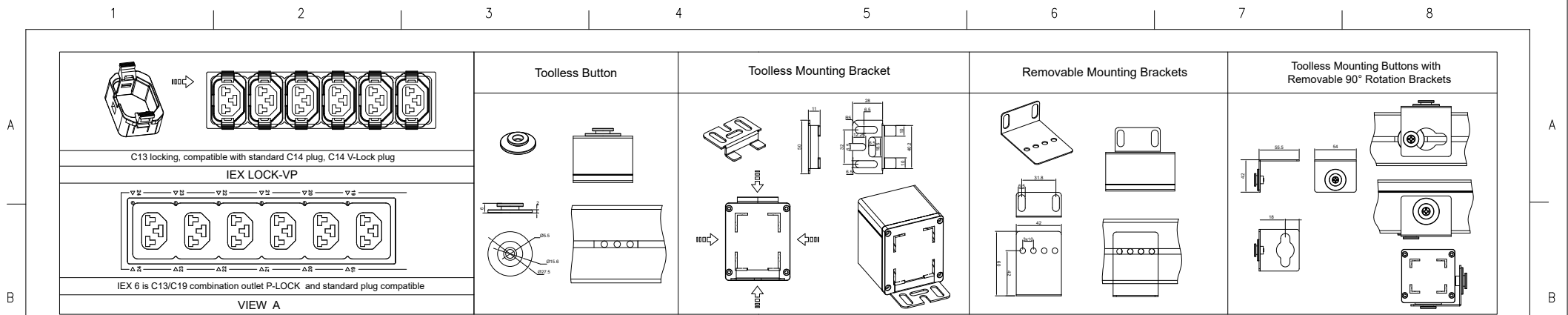



Chassis Color	Code
Black	Standard color
White	W
Red	R
Blue	A
Green	G
Orange	O
Grey	GY
Yellow	Y

Packing content:
 IEX Lock-VP  X24 (black,grey)

POMS Series Inlet Power Monitoring Per Outlet Monitoring&Switching Environmental Monitoring	OUTPUT (12) IEX (C13/C19) combo with LED Black (Max rate 16A) (12) IEX (C13/C19) combo with LED Grey (Max rate 16A)	OPERATING TEMPERATURE 0° to 60°C	Revisions		
			Rev	Description	Date
INPUT 190-250VAC 32A 50HZ IEC60309 32A 1P+N+E Plug 3m H07RN-F3G4mm² Power Lead	BRANCH CIRCUITS (2) 1 Pole Carling 16A J Series J51-BO-24-616-M1D-D3	MOUNTING ACCESSORIES (2) Toolless Button (2) Toolless Mounting Bracket (2) Removable Mounting Brackets (2) Toolless Mounting Buttons with Removable 90° Rotation Brackets			

DRAWING TYPE		IEXCBPOMS502432AV	
 (NO PERMISSION,NO CHANGING)		Housing Aluminium Black Powder Coating RAL9004	
unit=mm TECHNICAL STANDARD IT11; NO RUST NO FLAW ON THE SURFACE			
FILLET ANGLE	R0.5 $\pm 0.5^\circ$		
FIRST ANGLE 			DATE 08-04-2023

- Low cost locking solution at both ends
- Different colors available
- Patented IEX locking system
- Locking sleeve for C13 and C19 plugs
- VDE, UL approved

IEX PATENTED LOCKING SOCKET - POWER CORD SOLUTION



C14 - C13 Sleeve
H05VV-F3G1 mm²

Color	0,5M	1M	2M
Black	✓	✓	✓
Red	✓	✓	✓
Blue	✓	✓	✓

C14PLOCK - C13 Sleeve
H05VV-F3G1 mm²

Color	0,5M	1M	2M
Black	✓	✓	✓
Red	✓	✓	✓
Blue	✓	✓	✓



C20PLOCK - C19 Sleeve
H05VV-F3G1,5 mm²

Color	1M	2M
Black	✓	✓
Red	✓	✓
Blue	✓	✓

C20PLOCK - C13 Sleeve
H05VV-F3G1 mm²

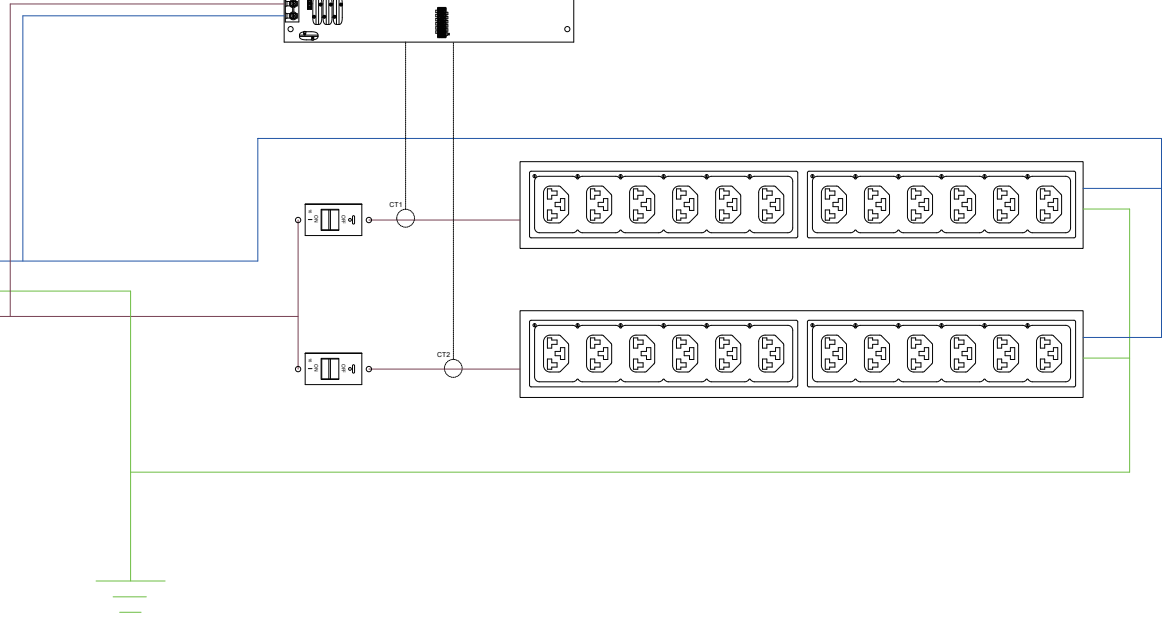
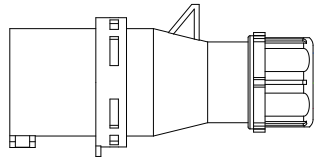
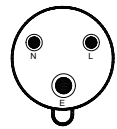
Color	1M	2M
Black	✓	✓
Red	✓	✓
Blue	✓	✓



DRAWING TYPE		IEXCBPOMS502432AV-wiring	
 (NO PERMISSION, NO CHANGING)		Housing	
unit=mm			
TECHNICAL STANDARD IT11; NO RUST NO FLAW ON THE SURFACE			
FILLET	R0.5		
ANGLE	±0.5°		
FIRST ANGLE			
			
		DATE 05-06-2021	

QTY	Part No.
1	PD090-3

Part No.
PP029-3

Part No.
PP081-4

Part No.
PP030-2

Part No.
PP070-3

QTY	Part No.
12	IEXLOCKB
12	IEXLOCKG

QTY	Part No.
2	MT190

QTY	Part No.
2	MT124-1

QTY	Part No.
2	PL178

QTY	Part No.
2	MT124-1

QTY	Part No.
2	MT190-2

QTY	Part No.
6	MT124

QTY	Part No.
2	PL178

QTY	Part No.
2	MT190-3

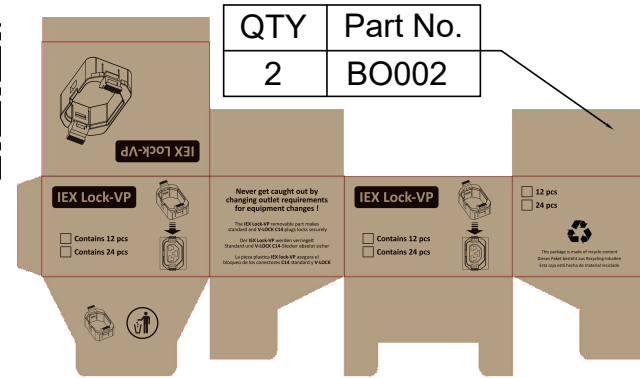

PK035
Section 23.5x9 cm Length 175 cm

Weight: 8kg(2 PDU)