

| FEATURES | |
|-------------------------------------|---|
| Technology | Basic |
| Energy Metering | No |
| Metering per Input Line | No |
| Metering per Output Receptacle | No |
| Remote Outlet Switching | No |
| Ethernet Port | No |
| Networking Protocols | No |
| PDU Cascading | No |
| Power Share | No |
| Display | No |
| Residual Current Monitoring | No |
| USB Ports | No |
| Environmental Sensors | No |
| INPUT | |
| Plug | IEC 60309 1P+N+E 6h 32A 250V SINGLE PHASE |
| Lead Length | 3 meter |
| Cable Type | H07RN-F3G4.0 mm ² |
| Max. Input Load | 32A |
| Rated Input Voltage | 190-250V Single phase |
| Frequency | 50-60Hz |
| Power Capacity | 7360W |
| OUTPUT | |
| Rated Output Voltage | 190-250V Single phase |
| Output Types | 24 IEX (C13/C19) combo (Max rate 16A) EN61984+UL498 certified |
| Overload Protection | (2) 1 Pole Carling 16A L Series L31-B0-24-616-H12-D3 |
| CHASSIS | |
| Dimensions (W x D x H) | 1042 x 55 x 55.4 mm |
| Color | RAL 9004 black powder coat |
| Mounting Options | 4 mounting options (see page 2) |
| Required Torque for Mounting Screws | ≥2.54N·m (25.9kgf·cm or 22.4 in·lbs) |
| OPERATING ENVIRONMENT | |
| Temperature Range | 0° to 60° C (30° to 140° F) |
| Humidity | 0 - 95 % |
| Elevation | 0 - 4000 Meters |
| CONFORMANCE | |
| IEC 62368-1 (Third Edition) | |
| | |

1 2 3 4 5 6 7 8

A

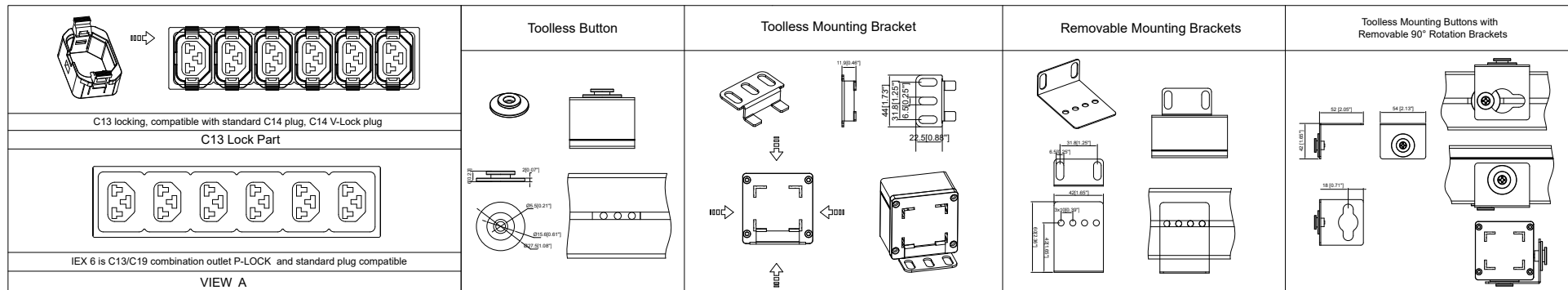

B

| Chassis Color | Code |
|---------------|----------------|
| Black | Standard color |
| White | W |
| Red | R |
| Blue | A |
| Green | G |
| Orange | O |
| Grey | GY |
| Yellow | Y |

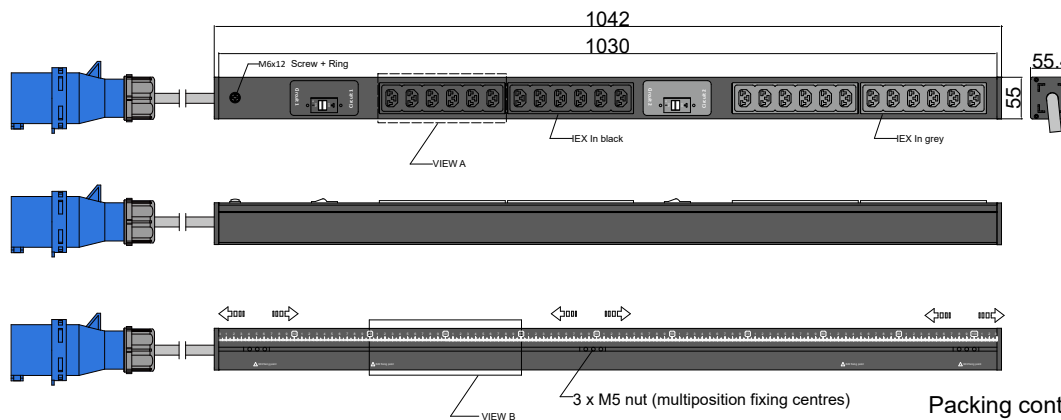

C

D

VIEW B:

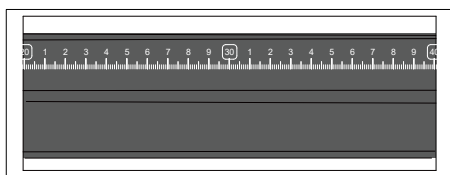



Packing content:

IEX Lock-VP  X24 (black, grey)

E

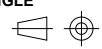
| | | | | | |
|--|--|--|------------------|-------------|------|
| Basic Series | OUTPUT (12) IEX (C13/C19) combo Black (Max rate 16A) (12) IEX (C13/C19) combo Grey (Max rate 16A) | OPERATING TEMPERATURE 0° to 60°C | Revisions | | |
| | | | Rev | Description | Date |
| INPUT 190-250VAC 32A 50HZ IEC60309 32A 1P+N+E Plug 3m H07RN-F3G4.0mm ² Power Lead | BRANCH CIRCUITS (2) 1 Pole Carling 16A L Series L31-B0-24-616-H12-D3 | MOUNTING ACCESSORIES (2) Toolless Button (2) Toolless Mounting Bracket (2) Removable Mounting Brackets (2) Toolless Mounting Buttons with Removable 90° Rotation Brackets | | | |

| | | |
|--|---|----------------------|
| DRAWING TYPE  (NO PERMISSION, NO CHANGING) | IEXCB452432AV | |
| unit=mm | Housing | Aluminium |
| TECHNICAL STANDARD IT11; NO RUST NO FLAW ON THE SURFACE | | Black Powder Coating |
| FILLET R0.5 ANGLE ±0.5° | | RAL9004 |
| FIRST ANGLE  |  | |
| | | |

F

1 2 3 4 5 6 7 8

- Low cost locking solution at both ends
- Different colors available
- Patented IEX locking system
- Locking sleeve for C13 and C19 plugs
- VDE, UL approved

IEX PATENTED LOCKING SOCKET - POWER CORD SOLUTION



C14 - C13 Sleeve

H05VV-F3G1 mm²

| Color | 0,5M | 1M | 2M |
|-------|------|----|----|
| Black | ✓ | ✓ | ✓ |
| Red | ✓ | ✓ | ✓ |
| Blue | ✓ | ✓ | ✓ |

C14PLOCK - C13 Sleeve

H05VV-F3G1 mm²

| Color | 0,5M | 1M | 2M |
|-------|------|----|----|
| Black | ✓ | ✓ | ✓ |
| Red | ✓ | ✓ | ✓ |
| Blue | ✓ | ✓ | ✓ |

C20PLOCK - C19 Sleeve

H05VV-F3G1,5 mm²

| Color | 1M | 2M |
|-------|----|----|
| Black | ✓ | ✓ |
| Red | ✓ | ✓ |
| Blue | ✓ | ✓ |

C20PLOCK - C13 Sleeve

H05VV-F3G1 mm²

| Color | 1M | 2M |
|-------|----|----|
| Black | ✓ | ✓ |
| Red | ✓ | ✓ |
| Blue | ✓ | ✓ |

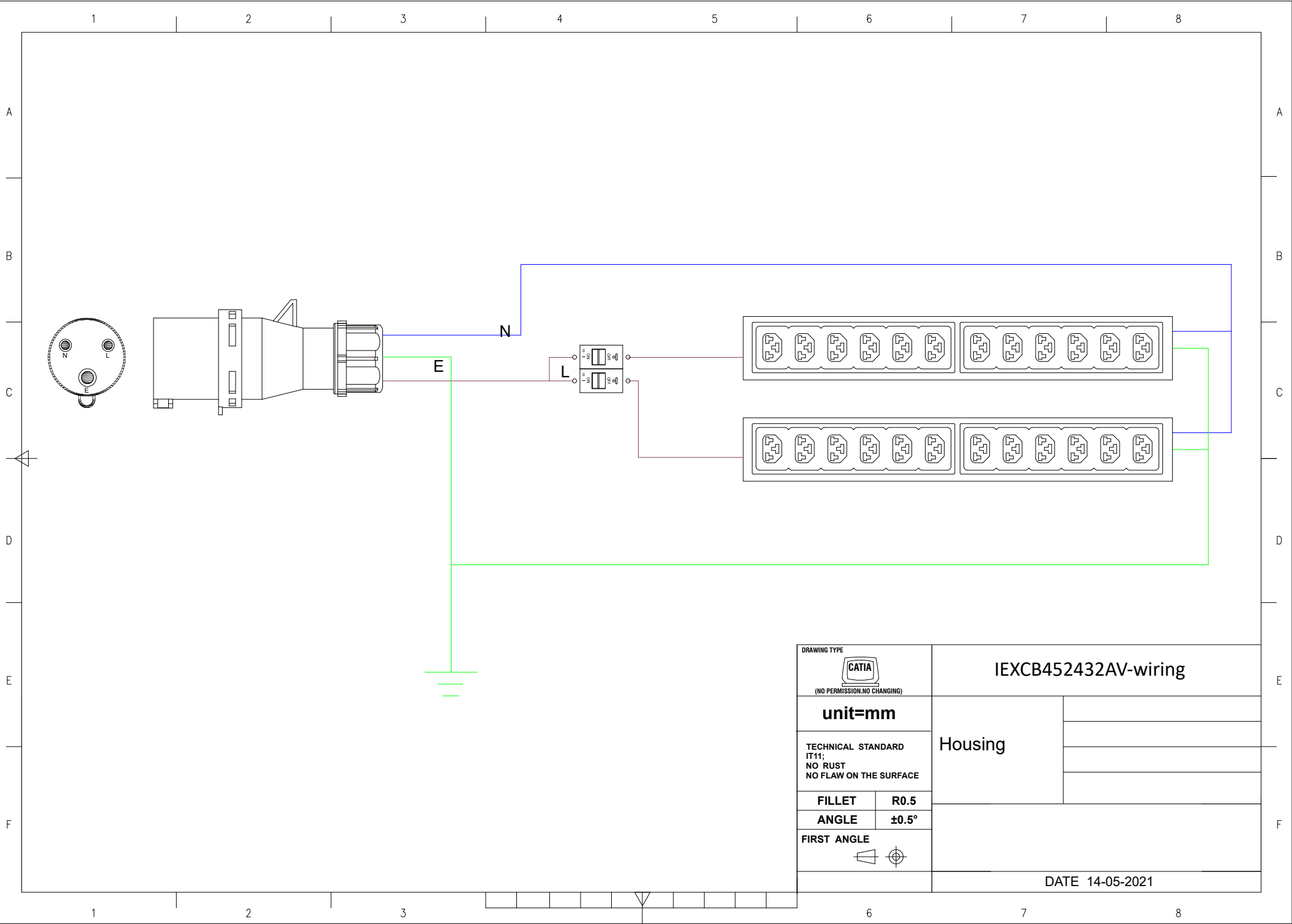

DRAWING TYPE

 (NO PERMISSION, NO CHANGING)

IEXCB452432AV-wiring

unit=mm

| | |
|---------|--|
| Housing | |
| | |
| | |

TECHNICAL STANDARD
 IT11;
 NO RUST
 NO FLAW ON THE SURFACE

FILLET **R0.5**

ANGLE **±0.5°**

FIRST ANGLE

DATE 14-05-2021

| QTY | Part No. |
|-----|----------|
| 12 | IEXLOCKB |
| 12 | IEXLOCKG |

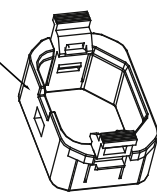

| QTY | Part No. |
|-----|----------|
| 2 | BO002 |

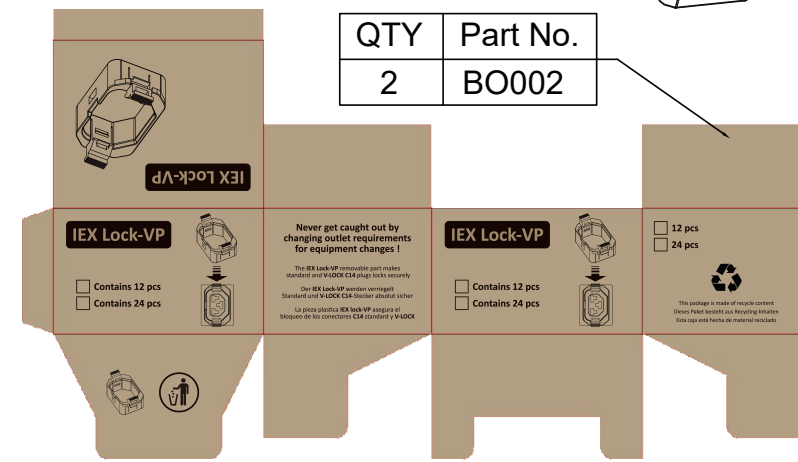

| | |
|----------|-------|
| Part No. | PP029 |
|----------|-------|

| | |
|----------|---------|
| Part No. | PP080-3 |
|----------|---------|

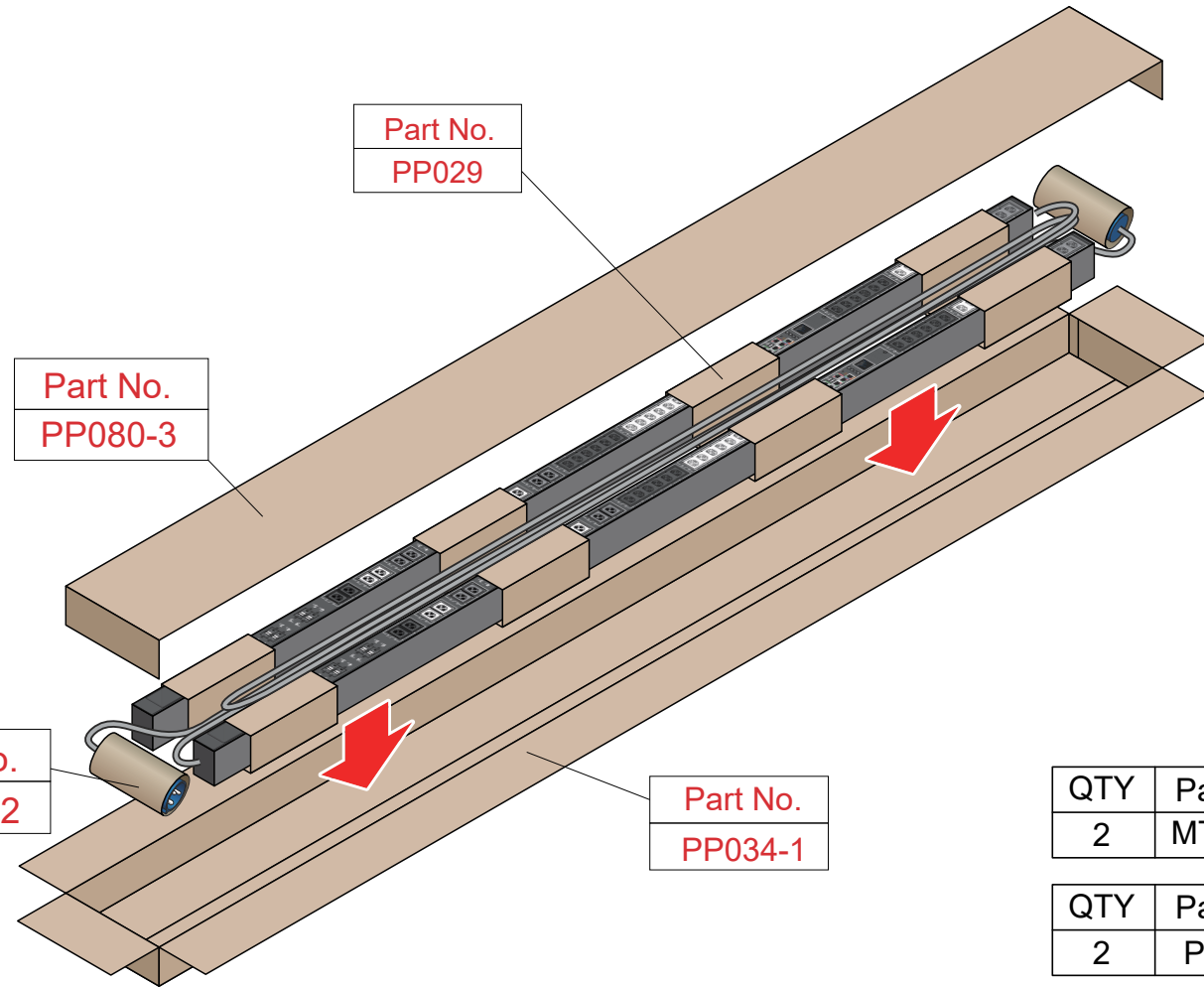

| | |
|----------|---------|
| Part No. | PP030-2 |
|----------|---------|

| | |
|----------|---------|
| Part No. | PP034-1 |
|----------|---------|

| QTY | Part No. |
|-----|----------|
| 2 | MT190-1 |

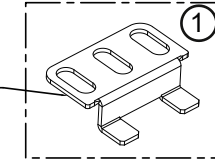

| QTY | Part No. |
|-----|----------|
| 2 | MT124-1 |

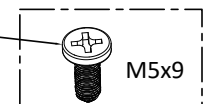

| QTY | Part No. |
|-----|----------|
| 2 | PL178 |

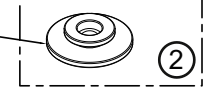

| QTY | Part No. |
|-----|----------|
| 2 | MT124-1 |

| QTY | Part No. |
|-----|----------|
| 2 | MT190-2 |

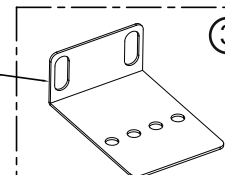

| QTY | Part No. |
|-----|----------|
| 6 | MT124 |

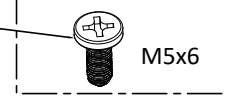

| QTY | Part No. |
|-----|----------|
| 2 | PL178 |

| QTY | Part No. |
|-----|----------|
| 2 | MT190-3 |

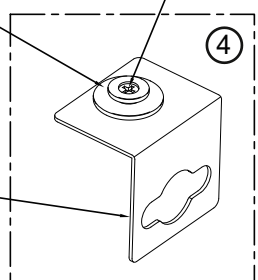

PK022
Section 22.5x7.2 cm Length 150 cm

Weight: 5kg(2 PDU)