

FEATURES

Technology	Basic
Energy Metering	No
Metering per Input Line	No
Metering per Output Receptacle	No
Remote Outlet Switching	No
Ethernet Port	No
Networking Protocols	No
PDU Cascading	No
Power Share	No
Display	No
Residual Current Monitoring	No
USB Ports	No
Environmental Sensors	No

INPUT

Plug	IEC60309 3P+N+E 6h 16A 380-415V
Lead Length	3 meter
Cable Type	H07RN-F5G2.5 mm ²
Max. Input Load	16A
Rated Input Voltage	380-415V three phase
Frequency	50-60Hz
Power Capacity	11kW

OUTPUT

Rated Output Voltage	190-250V Single phase
Output Types	42 IEX (C13/C19) combo (Max rate 16A) EN61984+UL498 certified
Overload Protection	None

CHASSIS

Dimensions (W x D x H)	1432 x 55 x 55.4 mm
Color	RAL 9004 black powder coat
Mounting Options	4 mounting options (see page 2)
Required Torque for Mounting Screws	≥2.54N·m (25.9kgf·cm or 22.4 in·lbs)

OPERATING ENVIRONMENT

Temperature Range	0° to 60° C (30° to 140° F)
Humidity	0 - 95 %
Elevation	0 - 4000 Meters

CONFORMANCE

IEC 62368-1 (Third Edition)



1 2 3 4 5 6 7 8

A

A

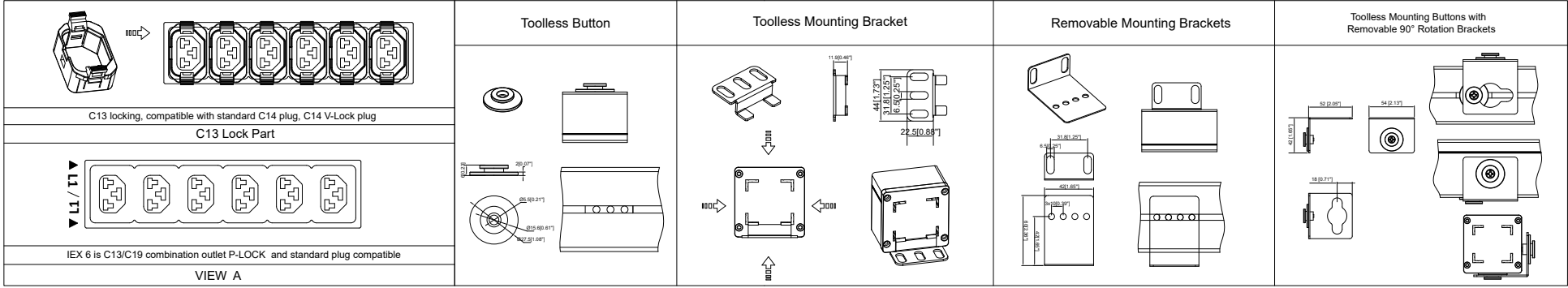

B

B

Chassis Color	Code
Black	Standard color
White	W
Red	R
Blue	A
Green	G
Orange	O
Grey	GY
Yellow	Y

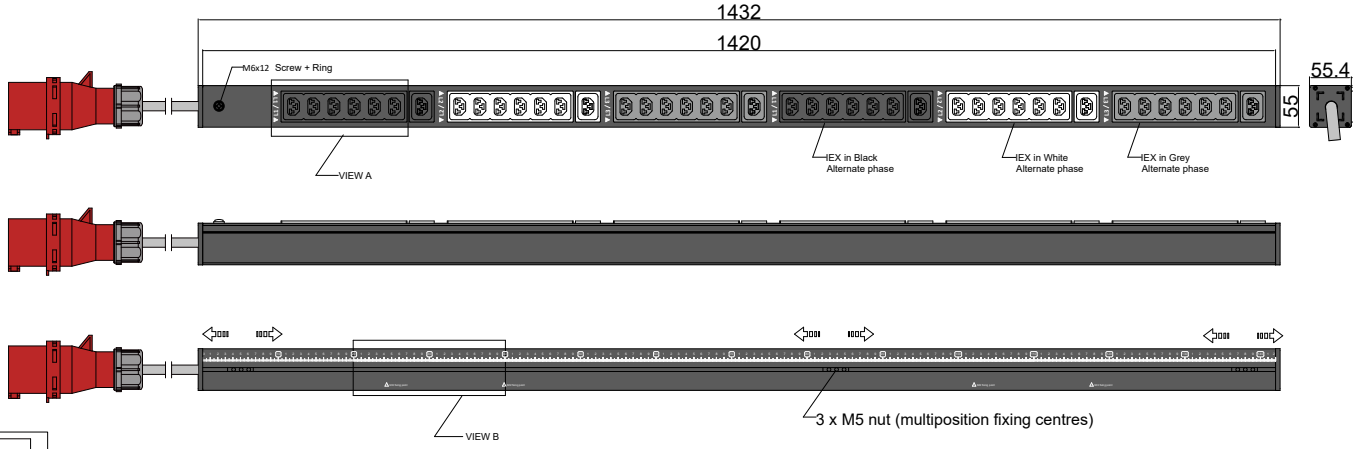

C

C

D

D

VIEW B:

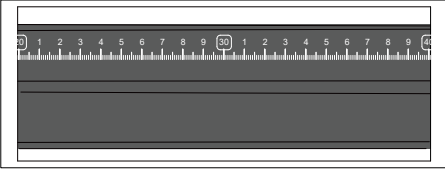

Packing content:

IEX Lock-VP  X42 (black,white,grey)

E

E

Basic Series INPUT 380-415VAC 16A 50HZ IEC60309 16A 3P+N+E Plug 3m H07RN-F5G2.5mm ² Power Lead	OUTPUT (14) IEX (C13/C19) combo Black (Max rate 16A) (14) IEX (C13/C19) combo White (Max rate 16A) (14) IEX (C13/C19) combo Grey (Max rate 16A)	OPERATING TEMPERATURE 0° to 60°C	Revisions			DRAWING TYPE  (NO PERMISSION, NO CHANGING)	IEX454216A3PV	
			Branch Circuits	MOUNTING ACCESSORIES (2) Toolless Button (2) Toolless Mounting Bracket (2) Removable Mounting Brackets (2) Toolless Mounting Buttons with Removable 90° Rotation Brackets	Rev Description Date		Fillet R0.5 Angle ±0.5° First Angle	Housing Aluminium Black Powder Coating RAL9004

F

F

1 2 3 4 5 6 7 8

- Low cost locking solution at both ends
- Different colors available
- Patented IEX locking system
- Locking sleeve for C13 and C19 plugs
- VDE, UL approved

IEX PATENTED LOCKING SOCKET - POWER CORD SOLUTION



C14 - C13 Sleeve

H05VV-F3G1 mm²

Color	0,5M	1M	2M
Black	✓	✓	✓
Red	✓	✓	✓
Blue	✓	✓	✓

C14PLOCK - C13 Sleeve

H05VV-F3G1 mm²

Color	0,5M	1M	2M
Black	✓	✓	✓
Red	✓	✓	✓
Blue	✓	✓	✓

C20PLOCK - C19 Sleeve

H05VV-F3G1,5 mm²



Color	1M	2M
Black	✓	✓
Red	✓	✓
Blue	✓	✓

C20PLOCK - C13 Sleeve

H05VV-F3G1 mm²

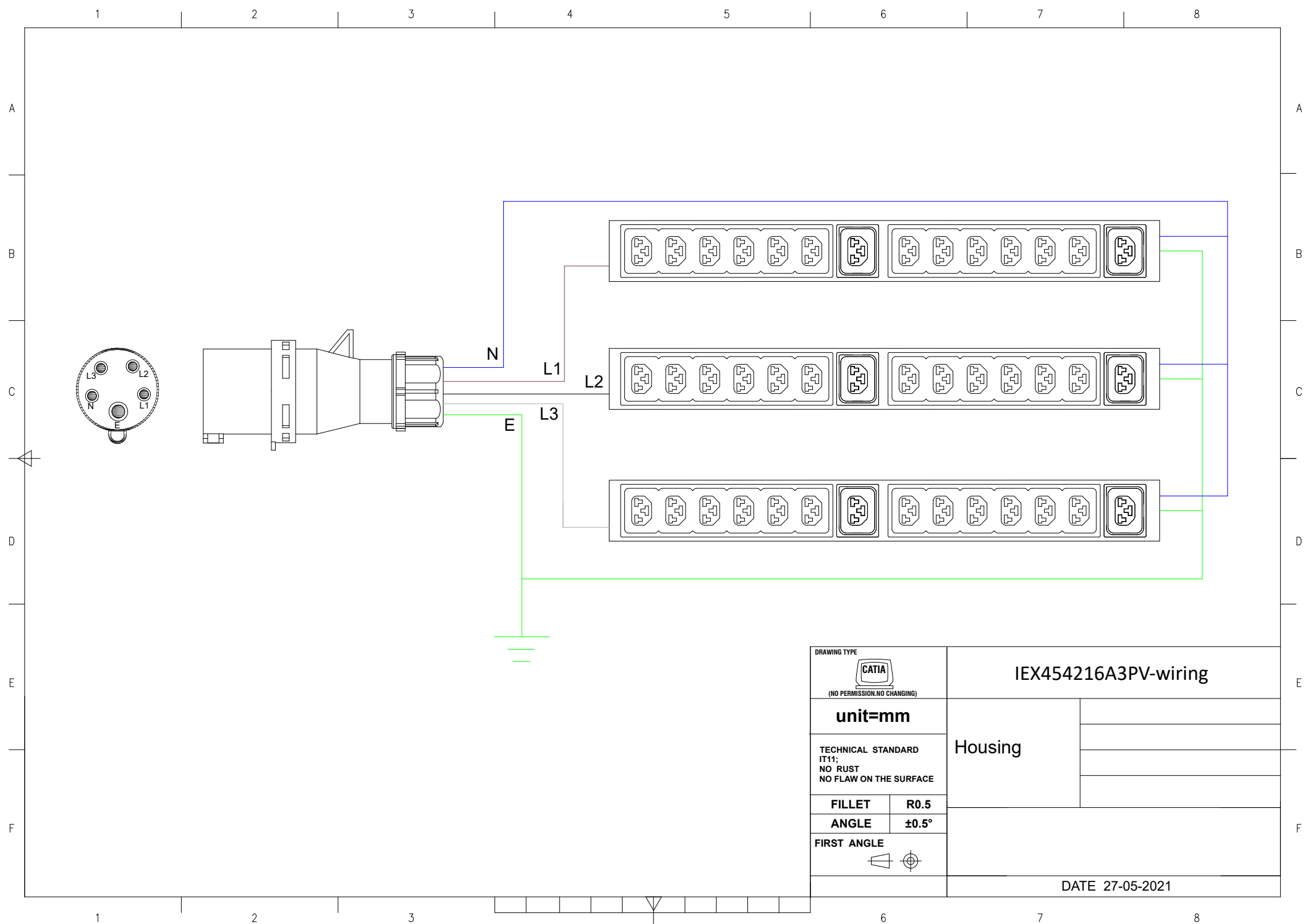
Color	1M	2M
Black	✓	✓
Red	✓	✓
Blue	✓	✓



DRAWING TYPE		IEX454216A3PV-wiring	
 (NO PERMISSION.NO CHANGING)		Housing	
unit=mm			
TECHNICAL STANDARD IT11; NO RUST NO FLAW ON THE SURFACE			
FILLET	R0.5		
ANGLE	±0.5°		
FIRST ANGLE 		DATE 27-05-2021	

QTY	Part No.
14	IEXLOCKB
14	IEXLOCKW
14	IEXLOCKG

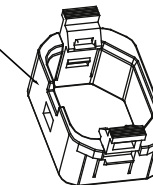

QTY	Part No.
4	BO002

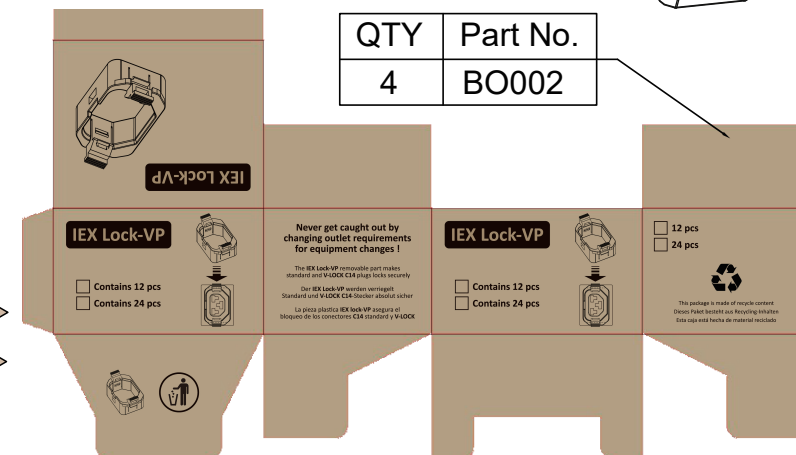

QTY	Part No.
2	MT190-1

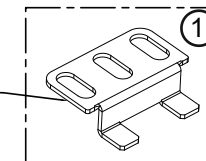

QTY	Part No.
2	MT124-1

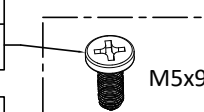

QTY	Part No.
2	PL178

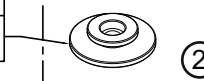

QTY	Part No.
2	MT124-1

QTY	Part No.
2	MT190-2

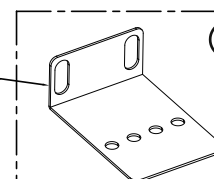

QTY	Part No.
6	MT124



QTY	Part No.
2	PL178

QTY	Part No.
2	MT190-3

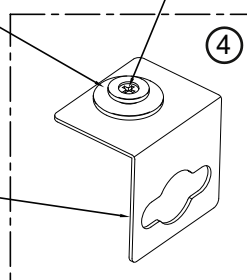

PK023
Section 22.5x7.2 cm Length 175 cm

Weight: 6kg(2 PDU)

Part No.
PP029

Part No.
PP080-4

Part No.
PP030-3

Part No.
PP035

