

FEATURES

Technology	PIM (Per Inlet Monitoring)
Energy Metering	Voltage(V), Current(A), Active Power(W), Apparent Power (VA), Reactive Power (var), PF, Frequency(Hz), kWh
Metering per Input Line	Yes (Branch Circuit and Total Current) Accuracy 1%
Metering per Output Receptacle	No
Remote Outlet Switching	No
Ethernet Port	2 Gigabit Ethernet ports to access the PDU from 2 different networks
Networking Protocols	DHCP, IPv4 and IPv6, DNS, http / https, SSHv.2, SNMP v1 / v2c / v3, SNMP TRAPS / SETS / GETS, SMTP, Modbus , Telnet, TCP, RADIUS, Syslog, TLS 1.2, SNTTP, ARP, ICMP, ICMPv6, UDP, NDP
PDU Cascading	16 PDUs
Power Share	Yes
Network Controller	Replaceable Hot Swapable controller with 4 button OLED display
Residual Current Monitoring	No (optional)
Rack Access Control	Compatible with DCIM solutions
USB Ports	2 USB A ports WiFi networking, webcam, PDU configuration and mobile interface
Environmental Sensors	All in one Temperature and Humidity sensor with 2 digital inputs (for connect air flow, door sensor, water leak, smoke detector and Vibration sensor) plug and play bus allows to connect 8 EMD devices in one PDU

INPUT

Plug	IEC60309 3P+N+E 6h 16A 380-415V
Lead Length	3 meter
Cable Type	H07RN-F5G2.5 mm ²
Max. Input Load	16A
Rated Input Voltage	380-415V three phase
Frequency	50-60Hz
Power Capacity	11kW

OUTPUT

Rated Output Voltage	190-250V Single phase
Output Types	12 IEX (C13/C19) combo (Max rate 16A) EN61984+UL498 certified
Overload Protection	None

CHASSIS

Dimensions (W x D x H)	482.8 x 88.4 x 160 mm
Color	RAL 9004 black powder coat
Mounting Options	(2) Metal bracket
Required Torque for Mounting Screws	≥2.54N·m (25.9kgf-cm or 22.4 in-lbs)

OPERATING ENVIRONMENT

Temperature Range	0° to 60° C (30° to 140° F)
Humidity	0 - 95 %
Elevation	0 - 4000 Meters

CONFORMANCE

IEC 62368-1 (Third Edition)



1 2 3 4 5 6 7 8

VIEW A:

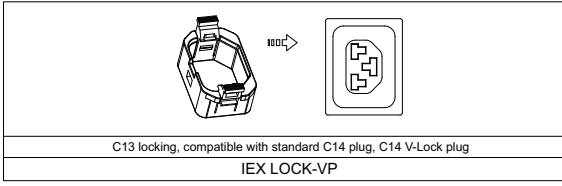

VIEW B:

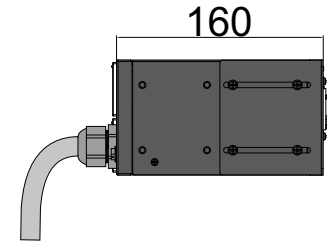
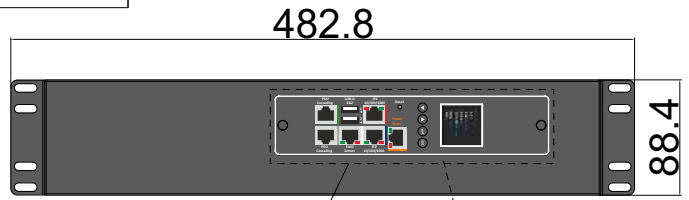
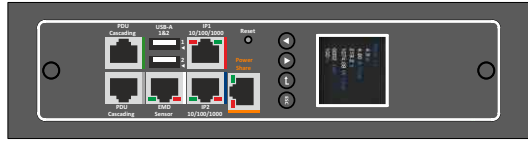

Hot Swap Control Module

Chassis Color	Code
Black	Standard color
White	W
Red	R
Blue	A
Green	G
Orange	O
Grey	GY
Yellow	Y

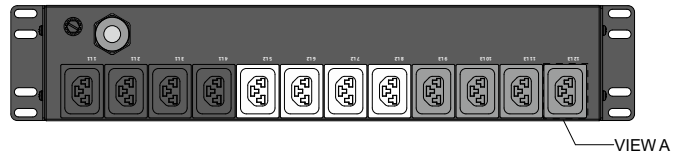
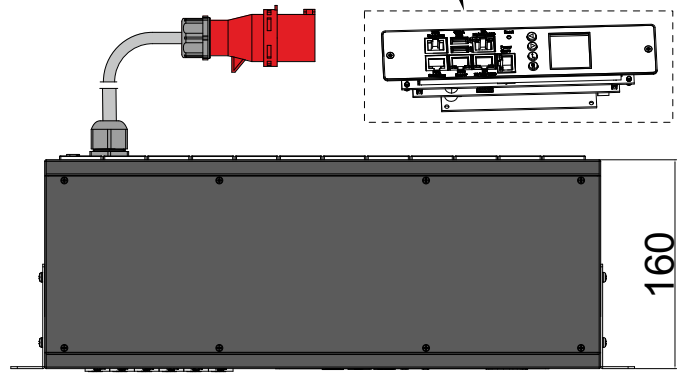



VIEW A

Packing content:

IEX Lock-VP  X12 (black,white,grey)

PIM Series Inlet Power Monitoring Environmental Monitoring	OUTPUT (4) IEX (C13/C19) combo Black (Max rate 16A) (4) IEX (C13/C19) combo White (Max rate 16A) (4) IEX (C13/C19) combo Grey (Max rate 16A)	OPERATING TEMPERATURE 0° to 60°C	Revisions		
			Rev	Description	Date
INPUT 380-415VAC 16A 50HZ IEC60309 16A 3P+N+E Plug 3m H05VV-F5G2.5mm ² Power Lead	BRANCH CIRCUITS	MOUNTING ACCESSORIES (2) Metal bracket			

DRAWING TYPE  (NO PERMISSION,NO CHANGING)	IEXPIM601216A3PH	
unit=mm TECHNICAL STANDARD IT11; NO RUST NO FLAW ON THE SURFACE	Housing	SECC Panel T=1.2mm Black Powder Coating RAL9004
FILLET R0.5 ANGLE ±0.5° FIRST ANGLE 		 DATE 18-07-2022

1 2 3 4 5 6 7 8

- Low cost locking solution t both ends
- Different colors available
- Patented IEX locking system
- Locking sleeve for C13 and C19 plugs
- VDE, UL approved

IEX PATENTED LOCKING SOCKET - POWER CORD SOLUTION



C14 - C13 Sleeve
H05VV-F3G1 mm²

Color	0,5M	1M	2M
Black	✓	✓	✓
Red	✓	✓	✓
Blue	✓	✓	✓

C14PLOCK - C13 Sleeve
H05VV-F3G1 mm²

Color	0,5M	1M	2M
Black	✓	✓	✓
Red	✓	✓	✓
Blue	✓	✓	✓

C20PLOCK - C19Sleeve
H05VV-F3G1,5 mm²

Color	1M	2M
Black	✓	✓
Red	✓	✓
Blue	✓	✓

C20PLOCK - C13Sleeve
H05VV-F3G1 mm²

Color	1M	2M
Black	✓	✓
Red	✓	✓
Blue	✓	✓

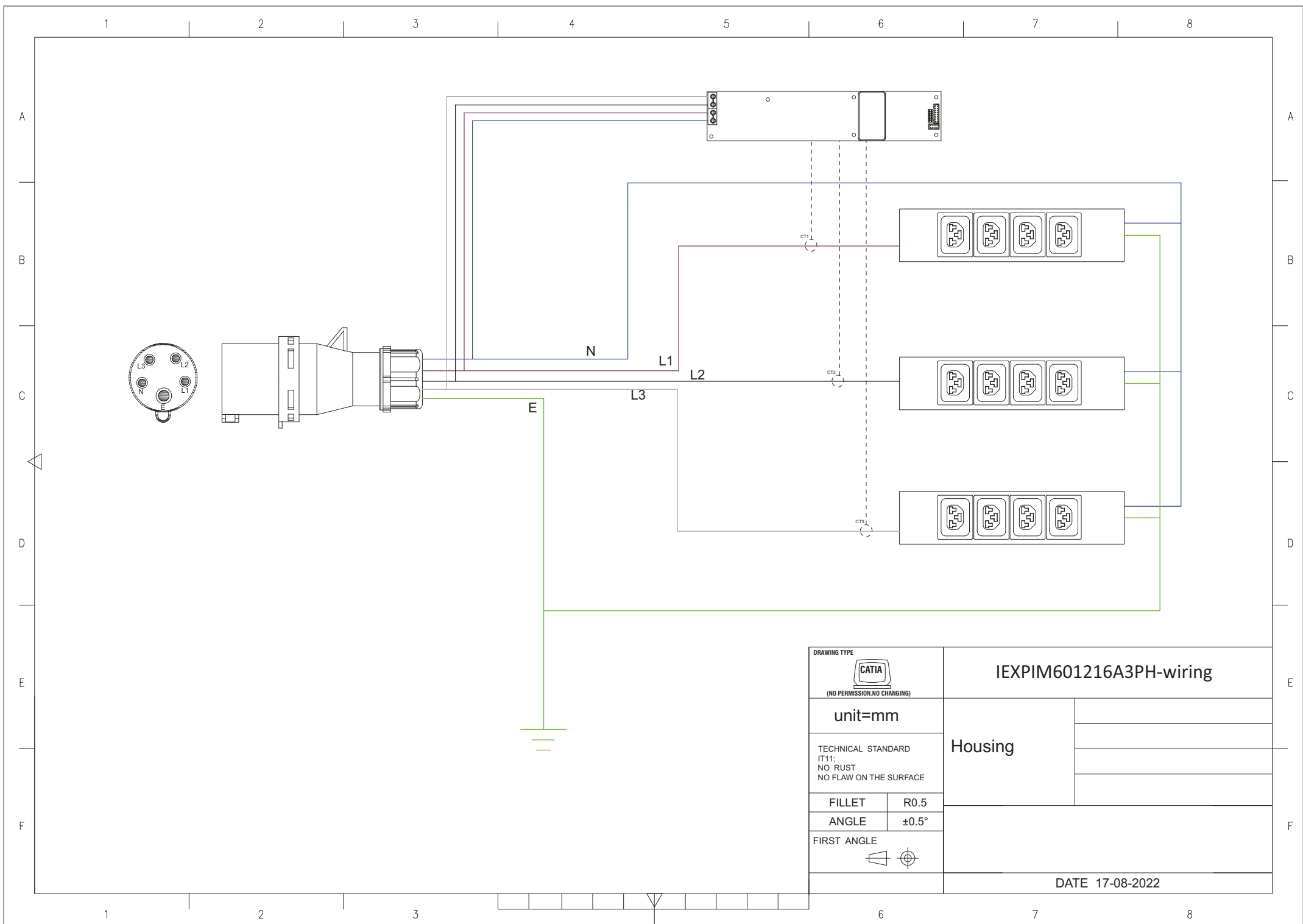

DRAWING TYPE		IEXPIM601216A3PH-wiring	
 (NO PERMISSION, NO CHANGING)		Housing	
unit=mm			
TECHNICAL STANDARD IT11; NO RUST NO FLAW ON THE SURFACE		DATE 17-08-2022	
FILLET	R0.5		
ANGLE	±0.5°		
FIRST ANGLE	