

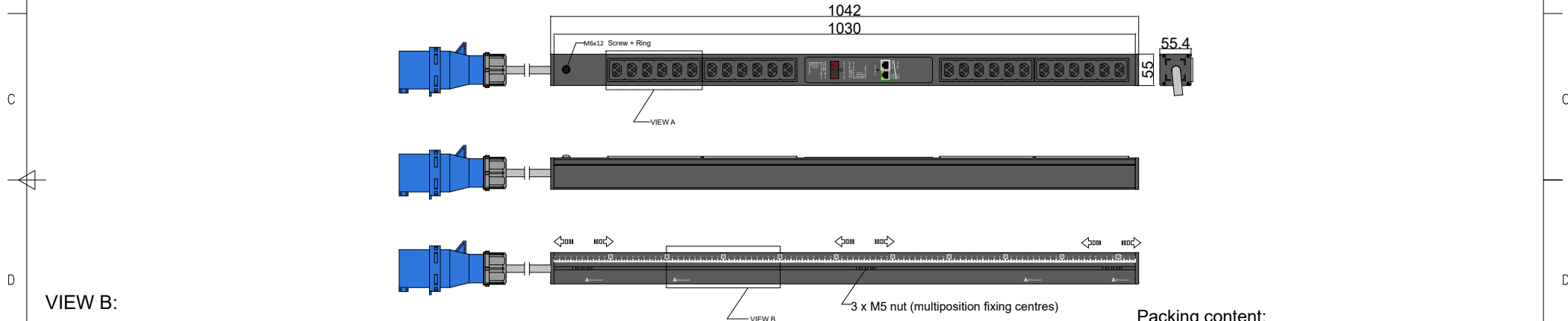

FEATURES	
Technology	PIM Lite (Per Inlet Monitoring)
Energy Metering	Voltage(V), Current(A), Active Power(kW), Real Power (KVA), Power Factor, kWh
Metering per Input Line	Yes (Branch Circuit and Total Current) Accuracy 1%
Metering per Output Receptacle	No
Remote Outlet Switching	No
Ethernet Port	1 Megabyte RJ45 port
Networking Protocols	DHCP, IPv4 and IPv6, DNS, http / https, SSHv.2, SNMP v1 / v2c / v3, SNMP TRAPS / SETS / GETS, SMTP, Modbus , TCP, RADIUS, Syslog, TLS 1.3, SNTp, ARP, ICMP, ICMPv6, UDP, NDP
PDU Cascading	No
Power Share	No
Network Controller	4 Digital-7 Segment Display LED
Residual Current Monitoring	No
USB Ports	No
Environmental Sensors	All in one Temperature and Humidity sensor with 2 digital inputs (for connect air flow, door sensor, water leak, smoke detector and Vibration sensor) plug and play bus allows to connect 8 EMD devices in one PDU
INPUT	
Plug	IEC 60309 1P+N+E 6h 16A 250V SINGLE PHASE
Lead Length	3 meter
Cable Type	H05VV-F3G1.5 mm <sup>2</sup>
Max. Input Load	16A
Rated Input Voltage	190-250V Single phase
Frequency	50-60Hz
Power Capacity	3680W
OUTPUT	
Rated Output Voltage	190-250V Single phase
Output Types	24 IEX (C13/C19) combo (Max rate 16A) EN61984+UL498 certified
Overload Protection	None
CHASSIS	
Dimensions (W x D x H)	1042 x 55 x 55.4 mm
Color	RAL 9004 black powder coat
Mounting Options	4 mounting options (see page 2)
Required Torque for Mounting Screws	≥2.54N·m (25.9kgf·cm or 22.4 in·lbs)
OPERATING ENVIRONMENT	
Temperature Range	0° to 60° C (30° to 140° F)
Humidity	0 - 95 %
Elevation	0 - 4000 Meters
CONFORMANCE	
IEC 62368-1 (Third Edition)	

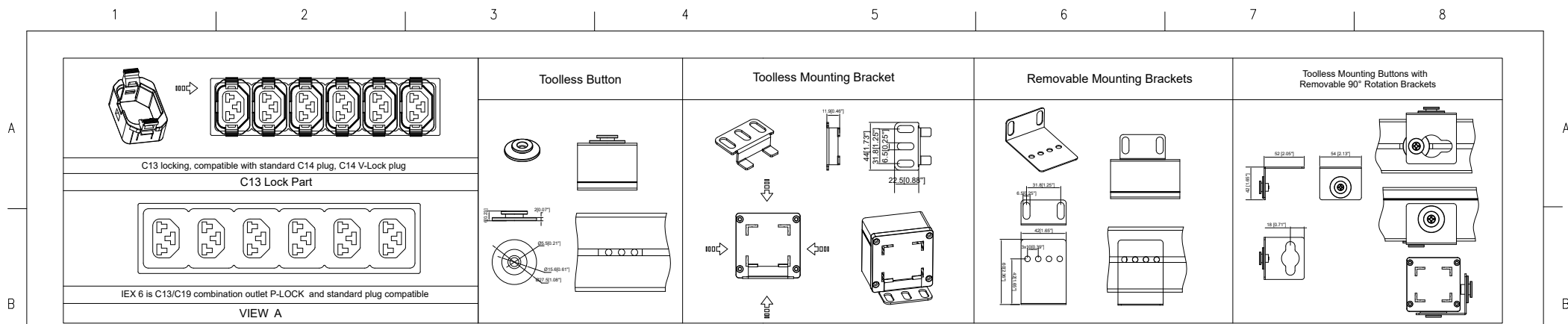

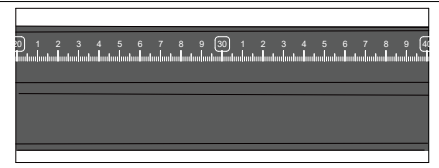

VIEW B:



Chassis Color	Code
Black	Standard color
White	W
Red	R
Blue	A
Green	G
Orange	O
Grey	GY
Yellow	Y

Packing content:  
IEX Lock-VP  X24 Black

<b>PIM Lite Series</b> Inlet Power Monitoring Environmental Monitoring	<b>OUTPUT</b> (24) IEX (C13/C19) combo Black (Max rate 16A)	<b>OPERATING TEMPERATURE</b> 0° to 60°C	<b>Revisions</b>		
			Rev	Description	Date
<b>INPUT</b> 190-250VAC 16A 50HZ IEC60309 16A 1P+N+E Plug 3m H05VV-F3G1.5mm <sup>2</sup> Power Lead	<b>BRANCH CIRCUITS</b>	<b>MOUNTING ACCESSORIES</b> (2) Toolless Button (2) Toolless Mounting Bracket (2) Removable Mounting Brackets (2) Toolless Mounting Buttons with Removable 90° Rotation Brackets			

DRAWING TYPE  (NO PERMISSION, NO CHANGING)	<b>IEXPIML452416AV</b>	
<b>unit=mm</b>  TECHNICAL STANDARD IT11; NO RUST NO FLAW ON THE SURFACE	<b>Housing</b>	Aluminium Black Powder Coating RAL9004
<b>FILLET</b> R0.5 <b>ANGLE</b> ±0.5° <b>FIRST ANGLE</b> 		
DATE 17-04-2023		

- Low cost locking solution at both ends
- Different colors available
- Patented IEX locking system
- Locking sleeve for C13 and C19 plugs
- VDE, UL approved

# IEX PATENTED LOCKING SOCKET - POWER CORD SOLUTION



## C14 - C13 Sleeve

H05VV-F3G1 mm<sup>2</sup>

Color	0,5M	1M	2M
Black	✓	✓	✓
Red	✓	✓	✓
Blue	✓	✓	✓

## C14PLOCK - C13 Sleeve

H05VV-F3G1 mm<sup>2</sup>

Color	0,5M	1M	2M
Black	✓	✓	✓
Red	✓	✓	✓
Blue	✓	✓	✓

## C20PLOCK - C19 Sleeve

H05VV-F3G1,5 mm<sup>2</sup>



Color	1M	2M
Black	✓	✓
Red	✓	✓
Blue	✓	✓

## C20PLOCK - C13 Sleeve

H05VV-F3G1 mm<sup>2</sup>

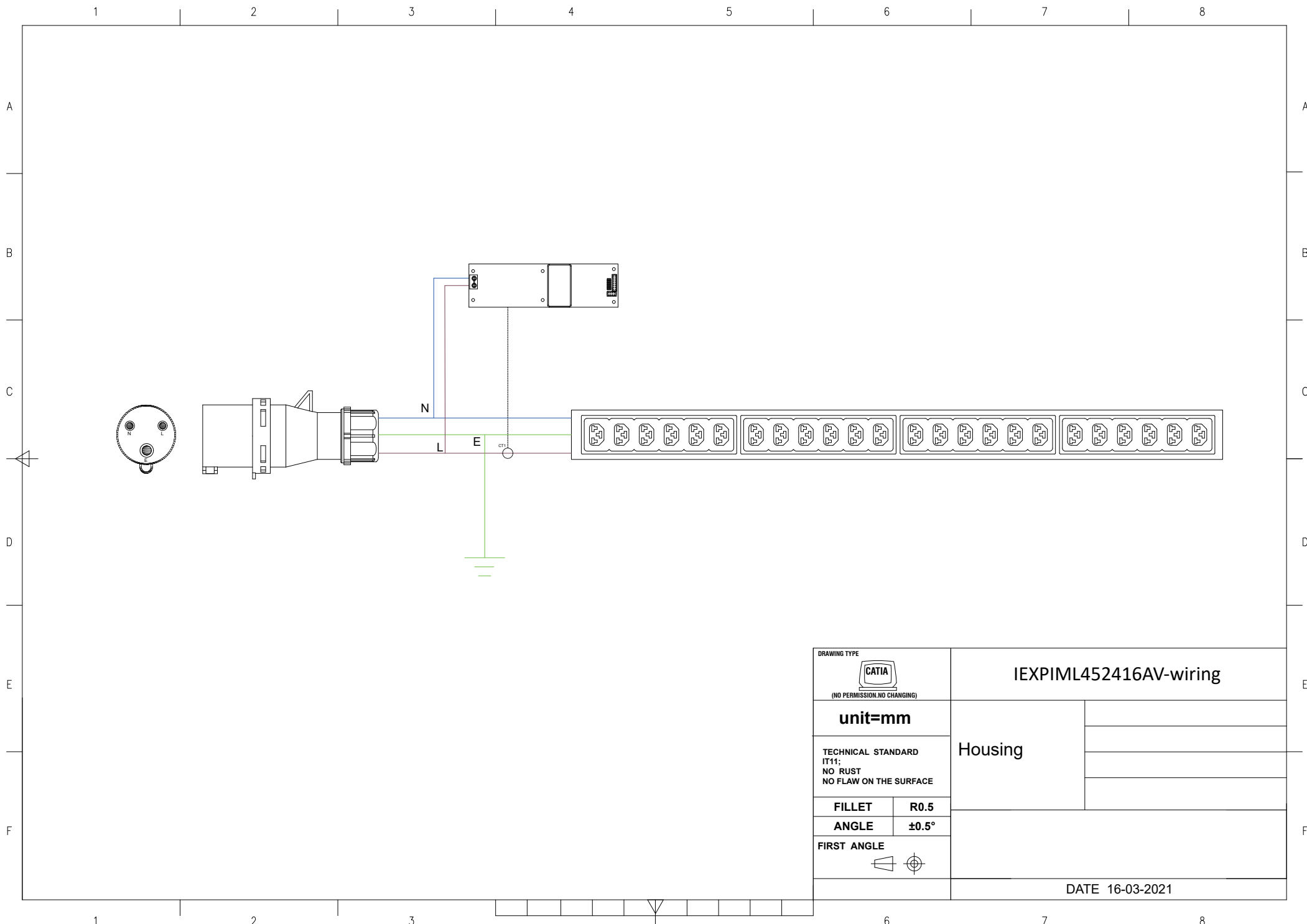
Color	1M	2M
Black	✓	✓
Red	✓	✓
Blue	✓	✓



DRAWING TYPE		IEXPIML452416AV-wiring	
 (NO PERMISSION, NO CHANGING)		Housing	
unit=mm			
TECHNICAL STANDARD IT11; NO RUST NO FLAW ON THE SURFACE			
FILLET	R0.5		
ANGLE	±0.5°		
FIRST ANGLE			
		DATE 16-03-2021	



QTY	Part No.
24	IEXLOCKB

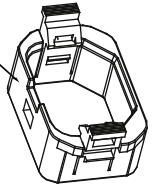

QTY	Part No.
2	BO002

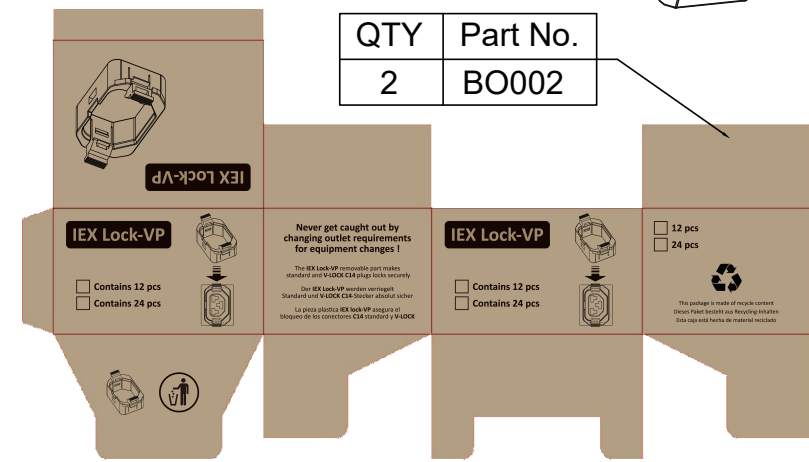

QTY	Part No.
2	MT190-1

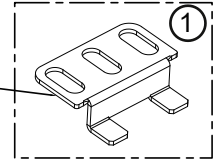

QTY	Part No.
2	MT124-1

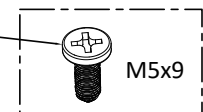

QTY	Part No.
2	PL178

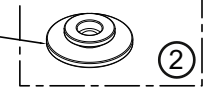

QTY	Part No.
2	MT124-1

QTY	Part No.
2	MT190-2

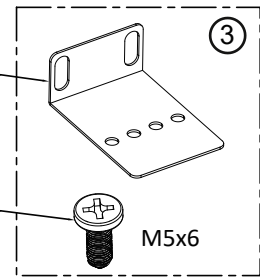

QTY	Part No.
6	MT124



Part No.
PP029

Part No.
PP080-2

Part No.
PP030-1

Part No.
PP034

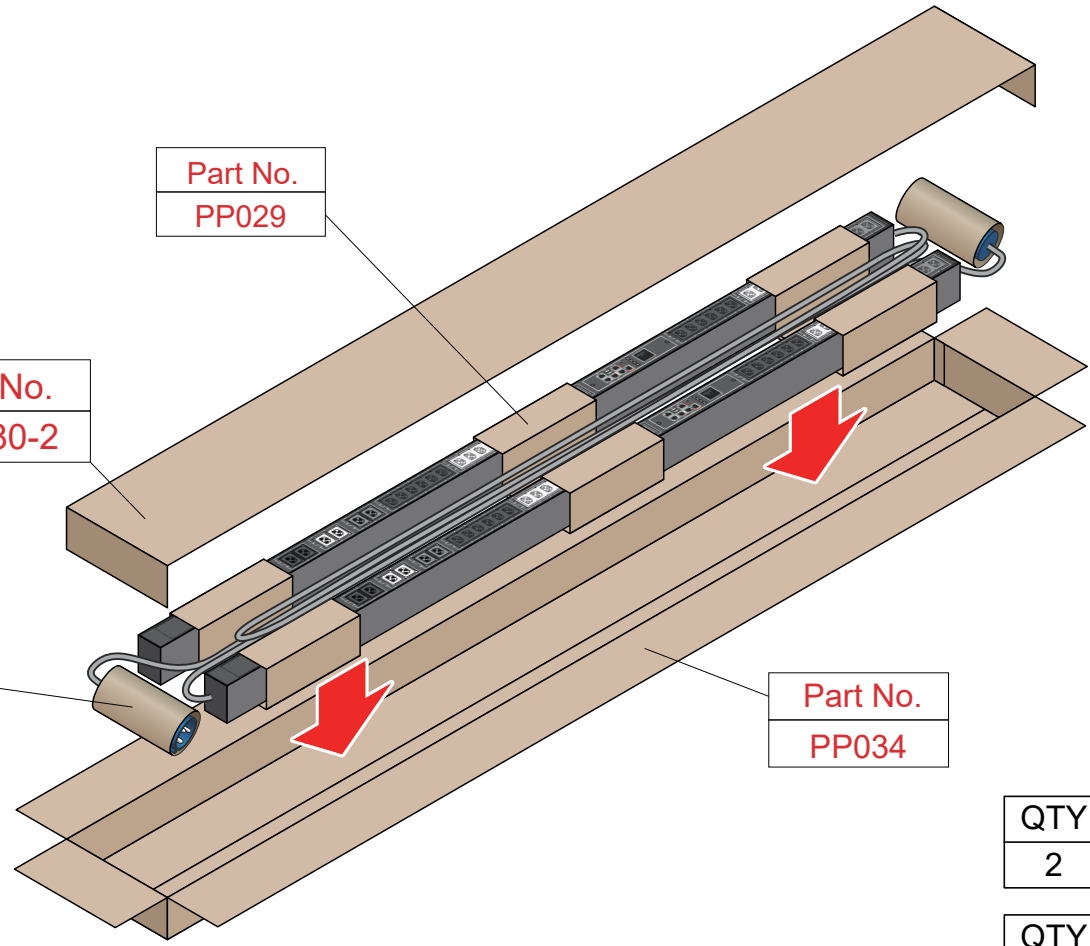

QTY	Part No.
2	PL178

QTY	Part No.
2	MT190-3

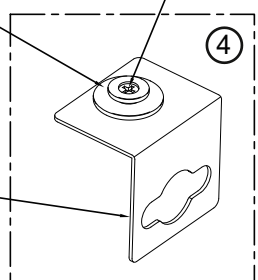

**PK021**  
Section 22.5x7.2 cm Length 120 cm

Weight: 6kg(2 PDU)