





FEATURES	
Technology	PIM Lite (Per Inlet Monitoring)
Energy Metering	Voltage(V), Current(A), Active Power(kW), Real Power (KVA), Power Factor, kWh
Metering per Input Line	Yes (Branch Circuit and Total Current) Accuracy 1%
Metering per Output Receptacle	No
Remote Outlet Switching	No
Ethernet Port	1 Megabyte RJ45 port
Networking Protocols	DHCP, IPv4 and IPv6, DNS, http / https, SSHv.2, SNMP v1 / v2c / v3, SNMP TRAPS / SETS / GETS, SMTP, Modbus , TCP, RADIUS, Syslog, TLS 1.3, SNTp, ARP, ICMP, ICMPv6, UDP, NDP
PDU Cascading	No
Power Share	No
Network Controller	4 Digital-7 Segment Display LED
Residual Current Monitoring	No
USB Ports	No
Environmental Sensors	All in one Temperature and Humidity sensor with 2 digital inputs (for connect air flow, door sensor, water leak, smoke detector and Vibration sensor) plug and play bus allows to connect 8 EMD devices in one PDU
INPUT	
Plug	IEC 60309 1P+N+E 6h 32A 250V SINGLE PHASE
Lead Length	3 meter
Cable Type	H07RN-F3G4.0 mm <sup>2</sup>
Max. Input Load	32A
Rated Input Voltage	190-250V Single phase
Frequency	50-60Hz
Power Capacity	7360W
OUTPUT	
Rated Output Voltage	190-250V Single phase
Output Types	42 IEX (C13/C19) combo (Max rate 16A) EN61984+UL498 certified
Overload Protection	(2) 1 Pole Carling 16A L Series L31-B0-24-616-H12-D3
CHASSIS	
Dimensions (W x D x H)	1812 x 55 x 55.4 mm
Color	RAL 9004 black powder coat
Mounting Options	4 mounting options (see page 2)
Required Torque for Mounting Screws	≥2.54N·m (25.9kgf·cm or 22.4 in·lbs)
OPERATING ENVIRONMENT	
Temperature Range	0° to 60° C (30° to 140° F)
Humidity	0 - 95 %
Elevation	0 - 4000 Meters
CONFORMANCE	
IEC 62368-1 (Third Edition)	
   	



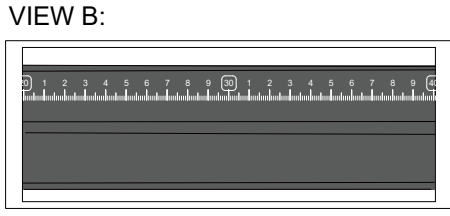
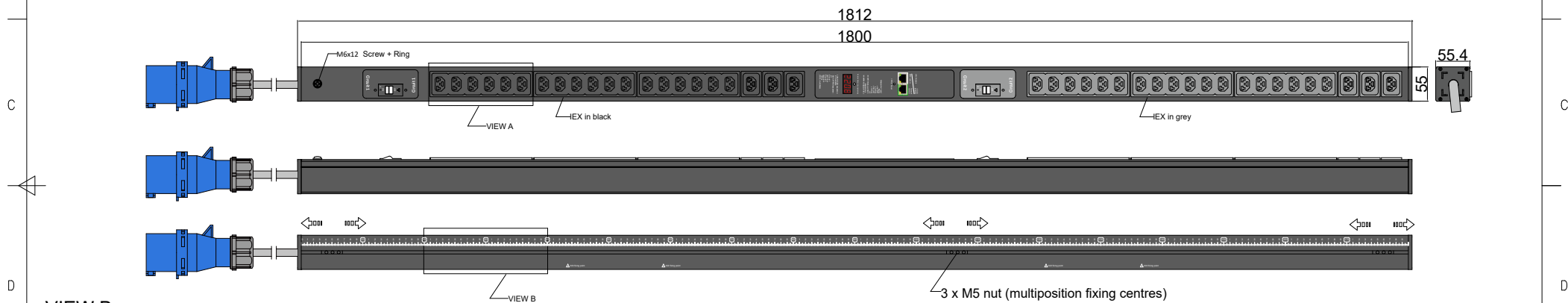
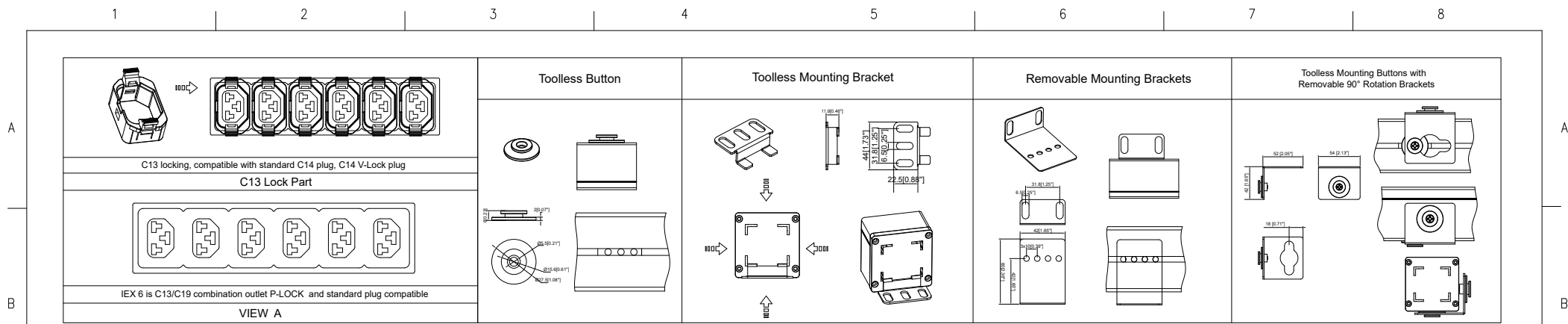

Chassis Color	Code
Black	Standard color
White	W
Red	R
Blue	A
Green	G
Orange	O
Grey	GY
Yellow	Y

Packing content:

IEX Lock-VP  X42 (black, grey)

<b>PIM Lite Series</b> Inlet Power Monitoring Environmental Monitoring	<b>OUTPUT</b> (21) IEX (C13/C19) combo Black (Max rate 16A) (21) IEX (C13/C19) combo Grey (Max rate 16A)	<b>OPERATING TEMPERATURE</b> 0° to 60°C
	<b>INPUT</b> 190-250VAC 32A 50HZ IEC60309 32A 1P+N+E Plug 3m H07RN-F3G4.0mm <sup>2</sup> Power Lead	<b>BRANCH CIRCUITS</b> (2) 1 Pole Carling 16A L Series L31-B0-24-616-H12-D3

Revisions		
Rev	Description	Date

DRAWING TYPE  (NO PERMISSION, NO CHANGING)	<b>IEXCBPIML454232AV</b>	
<b>unit=mm</b>  TECHNICAL STANDARD IT11; NO RUST NO FLAW ON THE SURFACE	<b>Housing</b>	Aluminium Black Powder Coating RAL9004
FILLET R0.5 ANGLE ±0.5° FIRST ANGLE 		
DATE 17-04-2023		

- Low cost locking solution at both ends
- Different colors available
- Patented IEX locking system
- Locking sleeve for C13 and C19 plugs
- VDE, UL approved

# IEX PATENTED LOCKING SOCKET - POWER CORD SOLUTION



## C14 - C13 Sleeve

H05VV-F3G1 mm<sup>2</sup>

Color	0,5M	1M	2M
Black	✓	✓	✓
Red	✓	✓	✓
Blue	✓	✓	✓

## C14PLOCK - C13 Sleeve

H05VV-F3G1 mm<sup>2</sup>

Color	0,5M	1M	2M
Black	✓	✓	✓
Red	✓	✓	✓
Blue	✓	✓	✓

## C20PLOCK - C19 Sleeve

H05VV-F3G1,5 mm<sup>2</sup>



Color	1M	2M
Black	✓	✓
Red	✓	✓
Blue	✓	✓

## C20PLOCK - C13 Sleeve

H05VV-F3G1 mm<sup>2</sup>

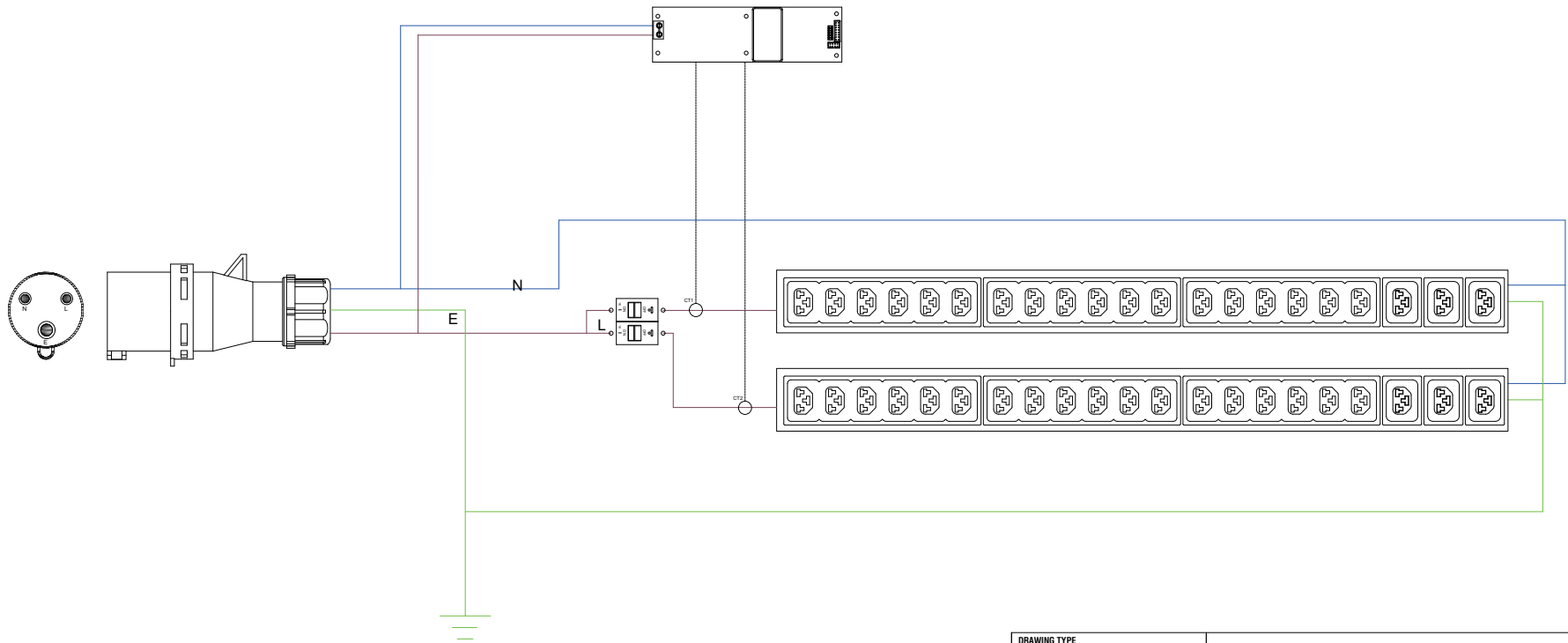
Color	1M	2M
Black	✓	✓
Red	✓	✓
Blue	✓	✓



DRAWING TYPE		IEXCBPIML454232AV-wiring	
 (NO PERMISSION, NO CHANGING)		Housing	
unit=mm			
TECHNICAL STANDARD IT11; NO RUST NO FLAW ON THE SURFACE			
FILLET	R0.5		
ANGLE	±0.5°		
FIRST ANGLE			
			
		DATE 21-12-2021	

QTY	Part No.
21	IEXLOCKB
21	IEXLOCKG

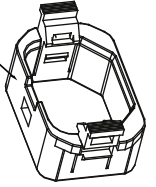

Part No.	PP029
----------	-------

QTY	Part No.
4	BO002

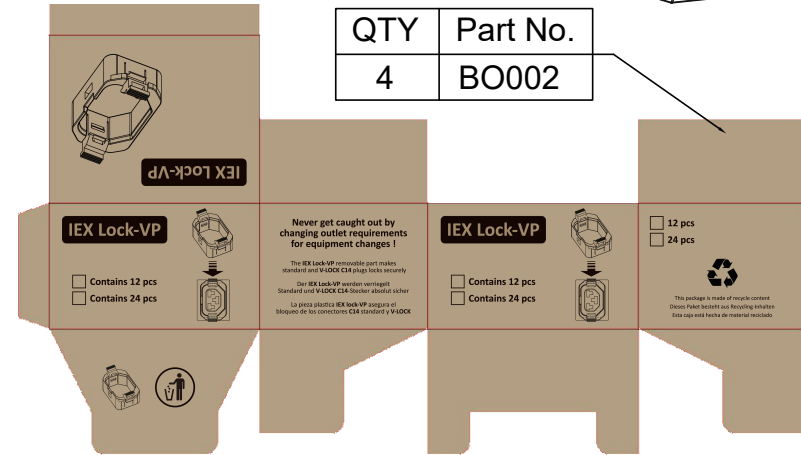

Part No.	PP080-5
----------	---------

Part No.	PP036-0
----------	---------

QTY	Part No.
2	MT190-1

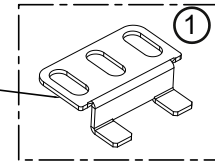

Part No.	PP030-2
----------	---------

QTY	Part No.
2	MT124-1

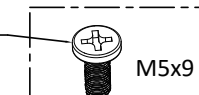

QTY	Part No.
2	PL178

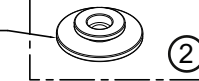

QTY	Part No.
2	MT124-1

QTY	Part No.
2	MT190-2

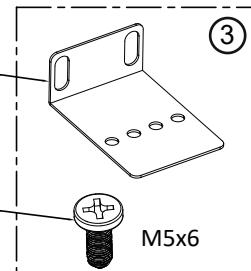

QTY	Part No.
6	MT124



QTY	Part No.
2	PL178

QTY	Part No.
2	MT190-3

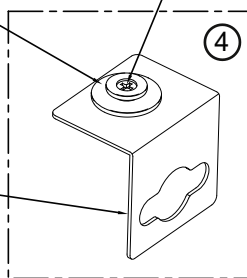

**PK024**  
Section 22.5x7.2 cm Length 200 cm

Weight: 7kg(2 PDU)